



DETYE VET SUPPLY, INC

2025



“SERVING YOUR ANIMAL HEALTH NEEDS FOR OVER TWENTY YEARS”

CALL 866-438-7541 TO ORDER



Dear Customer,



Landry (20 years), Arina (16 years), Blaisely (10 years)

Here at DeTye Vet Supply, we are looking forward to a great year. We are optimistic for good moisture this spring and summer and solid prices this fall for our cow/calf producers. We can all agree that we are due for a year where everything comes together for the ranchers out there. It seems that the cost of doing business is going up everywhere around us. Rest assured that at DeTye, we fight everyday to keep our prices down for you. At the end of the day your bottom line is our bottom line. Beyond our lowest prices we strive to not give into the “new normal”. Customer service is our foundation and you—the customer—should expect that. We work hard to be there for you when you need us. Whether that’s finding sensible options for products that may not be available or back stocking inventory so when you need it you can have it. We look forward to visiting with you this spring about “all your animal health needs”.

Sincerely,
Tyler & Dee Haugen

WHAT SETS DETYE APART

- We aim to be the most competitive and will beat prices.
- We ship Overnight, UPS, United States Postal, Federal Express, Overnight 2 day & 3 Day Select.
- Free Shipping on all orders of \$300 or more.
- We pride ourselves on quick, safe delivery. All temperature sensitive products are packed thoroughly to maintain proper temperatures.
- Service is very important to us—living in rural areas, we understand the value in this.
- We offer a consulting veterinarian to help you plan your health programs.
- We accept Discover, MasterCard and Visa.

DETYE VET SUPPLY, INC.
TYLER & DEE HAUGEN
21336 HARP ROAD
STURGIS, SD 57785

TOLL FREE: 866-438-7541
OFFICE 605-347-5536
FAX: 605-347-6004
EMAIL DE-TYE@MSN.COM
WEBSITE: WWW.DETYE.COM

INDEX

Biologicals	6-22	General Supplies	31-38
Clostridials	6-7	Banders	35
Pinkeye	8	Calf pullers	38
Reproductive	12,14,15	Clippers	34
Respiratory	16,18, 19, 20	Hot Shots	34
Scour	20	Measuring tapes	31
Tetanus	8	OB	35
		Oh No More	35
		Scrubs & Antiseptics	33
		Pneu-Dart Gun	30
		Cross 5 Cooler	33
Branding Irons	24	Identification	40-44
		Eartags	40-44
Fluids and Drug Administration	25-32	EID	40-41
Automatic Syringes	26-28	Marking Pens	44
Drencher & Dosers	25	Paint sticks	44
Needles	30	Tag Removers	44
Syringes	31		
		Paraticides & Dewormers	50-63
Diets and Nutrition	45-49	Dewormers	56-59
Appetite Stimulants	46	Fly Tags	61-63
Catl Active	46	Topical Insecticides	55
Digestive Health	46		
Electrolytes	45	Pharmaceuticals	65-71
Immune Supplements	47	Anticoccidials	65
Meal Replacers	45	Antidiarrheals	65
Vitamins & Nutrients	49	Hormones	70
		Implants	66-69
		Breeding Supplies	71
Equine Biologicals & Supplies	72-75		
Dewormers	75		
Equine Vaccine	72-73		
Feed Supplements	73		
Influenza/Rhino	73		
Zesterra	73		
DeTye Saddle	75		

**THEY SAY YOU SHOULDN'T PICK FAVORITES,**

BUT THERE ARE A FEW STAND-OUT PRODUCTS IN THE DETYE INVENTORY THAT DESERVE EXTRA RECOGNITION. LOOK FOR THIS BUTTON FOR SOME OF OUR FAVORITE PRODUCTS.



THE FUTURE LOOKS STRONG

DeTye Vet Supply recognizes the importance of our youth. We are giving back to the producers who have been a huge part of our success by awarding a \$1000 college scholarship to a DeTye customer or a child of a customer.

Applications due and must be postmarked by **July 1st, 2025**.

No late applications will be considered and must be complete, along with essay.

Applicant must have enrolled or demonstrated bonafide intention of enrolling in a college, university, or vocational school, excluding correspondence school.

Scholarship winner will receive scholarship upon enrollment of 2nd semester (spring semester) of college, university or vocational school. This scholarship will be awarded to seniors in high school working towards their first year of secondary education.

Applications are being accepted for the 2025 college scholarship.

If you are interested in applying or know someone who would be, please call 866-438-7541 or email de-tye@msn.com.



DeTye Vet Supply is proud to be involved with University of Wyoming's Steer a Year program.



WHAT YOUR ORDER WILL LOOK LIKE



WE SHIP WHAT YOU NEED TO YOUR DOORSTEP

From Carlin, NV to Quinn, SD and Albany County to Kildeer, ND— we guarantee the integrity of the medicine that you receive.

THE STAFF AT DETYE

ROY HENDRICKSON



Roy has lived in Western South Dakota his entire life. His family has ranched east of Caputa since 1983. Roy grew up part of a rodeo family, participating in youth, high school, college, and professional rodeo. Roy attended Kansas State University and holds a bachelor's degree in Animal Science and Industry. He has worked in the veterinary industry for over twenty years.

Roy and his wife Christi continue to raise commercial beef with the help of their adult children.

DETYE VET SUPPLY PROUDLY SPONSORS OUR LOCAL YOUTH











SDHSRA











Clostridial Vaccines

	PRODUCT	DESCRIPTION	ITEM#	SIZE	PRICE
Boehringer Ingelheim		Alpha-7™ Clostridium Chauvoei-Septicum-Novyi-Sordellii-Perfringens Types C & D Bacterin-Toxoid, cattle (including bred and/or lactating beef and dairy cattle).	010284	10 Dose	\$13.49
			010285	50 Dose	\$62.59
		Alpha-CD™ Clostridium Perfringens Types C & D Toxoid, cattle.	011483	10 Dose	\$11.69
			011484	50 Dose	\$53.59
		Bar-Vac® 7 Clostridium Chauvoei-Septicum-Novyi-Sordellii-Perfringens Types C & D Bacterin-Toxoid, cattle and sheep.	013871	10 Dose	\$11.69
			013872	50 Dose	\$49.99
		Bar-Vac® 7/Somnus Clostridium Chauvoei-Septicum-Novyi-Sordellii-Perfringens Types C & D-Haemophilus Somnus Bacterin-Toxoid, cattle.	002193	10 Dose	\$18.29
			002156	50 Dose	\$85.49
		Bar-Vac® CD Clostridium Perfringens Types C & D Toxoid, cattle and sheep.	007041	50 Dose	\$28.49
		Caliber® 7 Clostridium Chauvoei-Septicum-Novyi-Sordellii-Perfringens Types C & D Bacterin-Toxoid, cattle (including bred and/or lactating beef and dairy cattle) and sheep.	018812	10 Dose	\$11.79
021605			50 Dose	\$53.29	
018813			250 Dose	\$237.49	
Merck		Calvary 9 Clostridium Chauvoei, Septicum, Haemolyticum, Novyi, Sordellii, Tetani, Perfringens Types B, C, and D Bacterin Toxoid.		10 Dose	\$19.93
				50 Dose	\$68.90
				125 Dose	\$155.50
		Vision® 7 Somnus with Spur® Clostridium Chauvoei-Septicum-Novyi-Sordellii-Perfringens Types C & D-Haemophilus Somnus Bacterin-Toxoid, cattle.	011809	10 Dose	\$19.12
			011810	50 Dose	\$76.46
			011811	250 Dose	\$345.33
		Vision® 7 with Spur® Clostridium Chauvoei-Septicum-Novyi-Sordellii-Perfringens Types C & D Bacterin-Toxoid, cattle and sheep.	001815	10 Dose	\$14.99
			001816	50 Dose	\$51.99
			011113	250 Dose	\$202.01
		Vision® CD with Spur® Clostridium Perfringens Types C & D Bacterin-Toxoid, cattle, sheep and goats.	018630	250 Dose	\$210.03



Clostridial Vaccines

	PRODUCT	DESCRIPTION	ITEM#	SIZE	PRICE	
Zoetis		Ultrabac® 7	Clostridium Chauvoei-Septicum-Novyi-Sordellii-Perfringens Types C & D Bacterin-Toxoid, cattle and sheep.	018105	10 Dose	\$6.64
				017978	50 Dose	\$30.98
				013262	200 Dose	\$116.27
		Ultrabac® 7/Somubac®	Clostridium Chauvoei-Septicum-Novyi-Sordellii-Perfringens Types C & D-Haemophilus Somnus Bacterin-Toxoid, cattle and calves.	017981	10 Dose	\$14.26
				017982	50 Dose	\$68.47
				013582	200 Dose	\$257.10
		Ultrabac® CD	Clostridium Perfringens Types C & D Bacterin-Toxoid, cattle and sheep.	018104	10 Dose	\$6.81
				017977	50 Dose	\$27.89
		UltraChoice™ 7	Clostridium Chauvoei-Septicum-Novyi-Sordellii-Perfringens Types C & D Bacterin-Toxoid, cattle and sheep.	017972	10 Dose	\$10.32
				018095	50 Dose	\$49.36
				019196	250 Dose	\$213.89

Clostridial with Tetanus Vaccines

	PRODUCT	DESCRIPTION	ITEM#	SIZE	PRICE	
Boehringer Ingelheim		Bar-Vac® CD/T	Clostridium Perfringens Types C & D-Tetanus Toxoid, sheep, goats and cattle.	003369	10 Dose	\$13.29
				003368	50 Dose	\$59.09
Merck		Covexin 8	For the vaccination of healthy cattle and sheep against diseases caused by Clostridium chauvoei, Cl. septicum, Cl. novyi Type B, Cl. haemolyticum (known elsewhere as Cl. novyi Type D), Cl. tetani and Cl. perfringens Types C and D	004895	10 Dose	\$19.00
				004795	50 Dose	\$68.09
		Vision® CD•T with Spur®	Clostridium Perfringens Types C & D-Tetani Bacterin-Toxoid, cattle, sheep and goats. Contains formaldehyde as a preservative.	010792	50 Dose	\$58.71

Miscellaneous Vaccines

	PRODUCT	DESCRIPTION	ITEM#	SIZE	PRICE	
Colorado Serum Co.		Anthrax Spore Vaccine	Anthrax Spore Vaccine, Nonencapsulated Live Culture, domestic farm animals	008472	10 Dose	\$15.59
				002775	50 Dose	\$72.99
		Wart Vaccine	Wart Vaccine, Killed Virus, cattle	011798	50cc	\$54.79
Elanco		Fusogard®	Fusobacterium Necrophorum Bacterin, adjuvanted with SuprImm®, cattle 6 months and older	017746	10 Dose	CALL FOR BEST PRICE
				017747	50 Dose	



DISCLAIMER

Because of ever-changing market prices & manufacturers programs, prices are subject to change without notice. You will be notified of all possible savings programs & price breaks to the best of our ability. We encourage you to call to discuss a program that would best fit your needs.





Because of the possibility of typographical or human error, DeTye disclaims responsibility for errors. DeTye also disclaims any responsibility for the use or misuse of products & the methods of use described in this catalog. The manufacturers label should always be followed. Purchasers & users should always follow their veterinarians recommendations.



Tetanus Toxoids & Antitoxins

		PRODUCT	DESCRIPTION	ITEM#	SIZE	PRICE
Boehringer Ingelheim		Tetguard™	Alum precipitated, purified toxoid for vaccination of horses, cattle and swine against tetanus. Administer SQ or IM.	011439	10 Dose	\$58.99
Colorado Serum Co.		Tetanus Antitoxin, Equine Origin	Recommended for use in domestic animals (horses, cattle, sheep and swine) as an aid in preventing and treating tetanus. Confers immediate passive immunity lasting about 7-14 days. Administer SQ or IV.	012700	15000u	\$93.29
		Tetanus Toxoid-Concentrated	For the vaccination of cattle, horses, sheep, goats and swine against tetanus. Administer IM.	007425	1500u	\$11.39
				028476	10 Dose	\$31.00
Merck		Prestige Tetanus Toxoid	Purified tetanus toxoid for vaccination of healthy horses, cattle, swine and sheep, 6 months of age or older, against tetanus. Administer IM.	001915	1 Dose	\$8.99

Pinkeye Vaccines

		PRODUCT	DESCRIPTION	ITEM#	SIZE	PRICE
Boehringer Ingelheim		Alpha-7/MB™-1	Clostridium Chauvoei-Septicum-Novyi-Sordellii-Perfringens Types C & D-Moraxella Bovis Bacterin-Toxoid, cattle.	026367	10 Dose	\$24.49
				026368	50 Dose	\$114.19
Merck		20/20 Vision® 7 with Spur®	Clostridium Chauvoei-Septicum-Novyi-Sordellii-Perfringens Types C & D-Moraxella Bovis Bacterin-Toxoid, cattle.	017881	10 Dose	\$27.88
				017882	50 Dose	\$114.47
		Piliguard® Pinkeye-1 Trivalent	Moraxella Bovis Bacterin, trivalent, cattle.	000414	10 Dose	\$20.49
				000643	50 Dose	\$85.63
Addison Labs		Moraxella Bovoculi Bacterin	For the vaccination of healthy cattle 14 weeks of age or older against pinkeye (infectious bovine keratoconjunctivitis). This product license is conditional; potency has not been fully demonstrated. See label for complete product details.		10 Dose	\$20.49
					50 Dose	\$90.89
Elanco		Pinkeye Shield™ XT4	Moraxella Bovis Bacterin, adjuvanted with Xtend® SP, cattle.	011805	10 Dose	CALL FOR BEST DETYE PRICING
				011806	50 Dose	

**WE SHIP ANYWHERE —
TENSLEEP, BILL, SCOTTSBLUFF, AND MAUI, HI.**

TALK DIRECTLY TO OUR TEAM AT 866-438-7541.

Elanco

Pradalex
(pradofloxacin injection)

In the race to treat BRD, speed wins.

Pradalex, a first-of-its-kind antibiotic, reaches peak concentration within 45 minutes and starts killing BRD bacteria within 5 minutes on contact.¹ While targeting two DNA replication sites, Pradalex hits BRD with 3x the power in less than half the time.^{1,2}

Faster recovery. Less stress³.
Everyone wins with Pradalex.

Beat BRD with Pradalex

¹Elanco Animal Health. Data on File.

²Blondeau, J.M.; Fitch, S.D. Comparative In Vitro Killing by Pradofloxacin in Comparison to Ceftriaxone, Enrofloxacin, Florfenicol, Marbofloxacin, Tildipirosin, Tilmicosin and Tulathromycin against Bovine Respiratory Bacterial Pathogens. *Microorganisms* 2024, 12

³Elanco Animal Health. Data on File.

IMPORTANT SAFETY INFORMATION

Caution: Federal law restricts this drug to use by or on the order of a licensed veterinarian. Not for use in humans. Keep out of reach of children. Avoid contact with eyes and skin. Individuals with a history of hypersensitivity to quinolones should avoid this product. Not for use in animals intended for breeding greater than 1 year of age because the effects of Pradalex on bovine reproductive performance, pregnancy, and lactation have not been determined. Not for use in beef and dairy calves less than 2 months of age, and veal calves; a withdrawal period has not been established for this product in pre-ruminating calves. Quinolones should be used with caution in animals with known or suspected central nervous system (CNS) disorders. Mild to moderate inflammatory changes of the injection site may be seen in cattle treated with Pradalex. See package insert for additional safety information.

Pradalex, Elanco and the diagonal bar logo are trademarks of Elanco or its affiliates.

©2024 Elanco. PM-DS-24-1407(2)

Right for cattle. Right by you.

Elanco

BEST



BEST PRICES. Best Service.



"I JUST RECEIVED A REBATE CHECK IN THE MAIL FROM ZOETIS FOR SOME MEDICATION I ORDERED. WHAT A NICE SURPRISE! I JUST WANTED TO SAY THANK YOU AND TELL YOU THAT THE CONSTANT ATTENTION TO DETAIL AND ALL THE DIFFERENT WAYS YOU CONTINUE TO PROVIDE CUSTOMER SUPPORT IS THE VERY BEST AND MUCH APPRECIATED. AND IT HAS NEVER CHANGED!"

-KATE T

866-438-7541
or visit: **www.detye.com**

DETYE

BOVILIS NASALGEN 3-PMH & BOVILIS VISTA BVD CFP

FAST FACTS



BOVILIS® NASALGEN® 3-PMH

- Intranasal vaccine mounts strong, early response for powerful, long-lasting protection
- Avoid missing calves or double dosing with the unique BluShadow™ diluent for confident administration
- BQA friendly
- Designed with an IBR that is not temperature-sensitive ensuring BOVILIS NASALGEN 3-PMH will replicate and protect regardless of ambient temperature¹
- Effectively protects beef and dairy cattle against five major causes of respiratory disease in one dose²:
 - Bovine respiratory syncytial virus (BRSV)
 - Infectious bovine rhinotracheitis (IBR)
 - Parainfluenza 3 (PI3)
 - *Pasteurella multocida*
 - *Mannheimia haemolytica*
- Duration of immunity (DOI)³:
 - BRSV: at least 78 days
 - IBR: at least 195 days
 - PI3: at least 95 days
 - *P. multocida*: at least 125 days
 - *M. haemolytica*: at least 122 days



BOVILIS® VISTA® BVD CFP

- BVD Type 1b cross protection⁴
- Cell-mediated immunity (CMI) for BVD Types 1 & 2⁴
- Effective against fetal infection, including persistently infected calves due to bovine virus diarrhea virus (BVD) Types 1 & 2⁵
- Proven to provide BVD protection in the face of maternal antibodies (IFOMA)⁶
- Labeled for use in pregnant heifers and cows or calves nursing pregnant cows⁷
- Viral antigens in VISTA are grown on fetal equine serum instead of fetal calf serum, eliminating the risk of off-target pathogen contamination⁸
- Increases productivity due to fewer reactions⁹, which leads to healthier cattle and higher profits
- Duration of immunity (DOI):
 - Respiratory: at least 365 days for BVD Types 1 & 2¹
 - Reproductive: at least 206 days BVD Types 1 & 2¹

References: 1. Grissett GP, et al. Effect of Ambient Temperature on Viral Replication and Serum Antibody Titers Following Administration of a Commercial Intranasal Modified-Live Infectious Bovine Rhinotracheitis-Parainfluenza-3 Virus Vaccine to Beef Cattle Housed in High- and Moderate-Ambient Temperature Environments. *Am J Vet Res.* 2014;75(12):1076-1082. 2. Bovilis Nasalgen 3-PMH. Product Label. 2021. 3. Xue W, Mattick D, Smith L, Umbaugh J, Trigo E. Vaccination with a modified-live bovine viral diarrhea virus (BVDV) type 1a vaccine completely protected calves against challenge with BVDV type 1b strains. 2010;29(1):70-6. doi: 10.1016/j.vaccine.2010.10.012. Epub 2010 Oct 27. 4. Platt R, Burdett W, Roth JA. Induction of antigen-specific T-cell subset activation to bovine respiratory disease viruses by a modified-live virus vaccine. *Am J Vet Res.* 2006;67(7):1179-1184. 5. Xue W, Mattick D, Smith L, Maxwell J. Fetal protection against bovine viral diarrhea types 1 and 2 after the use of a modified-live virus vaccine. *Can J Vet Res.* 2009;73(4):292-297. 6. Stevers, et al. *Bovine Practitioner* 2011. 7. Bovilis Vista BVD CFP. Product Label. 2021. 8. Northhoff H, Flegel WA. Fetal Calf Serum in *Encyclopedia of Immunology* (Second Edition). 1998. 9. Effects of Vaccination with Vista® 5 L5 SQ or Bovil Shield GOLD® FP® L5 on Milk Production.

Reproductive Vaccines

		PRODUCT	DESCRIPTION	ITEM#	SIZE	PRICE	
Boehringer Ingelheim		Express® FP 10 HB	Bovine Rhinotracheitis-Virus Diarrhea-Parainfluenza3-Respiratory Syncytial Virus Vaccine, Modified Live Virus, Leptospira Canicola-Grippotyphosa-Hardjo-Icterohaemorrhagiae-Pomona Bacterin, cattle.	034418	10 Dose	\$25.99	
				034419	50 Dose	\$120.29	
		Express® FP 3 VL5 HB	IBR, BVD Types I and II, Vibrio and 5 strains of Lepto including hardjo-bovis. Do not use in pregnant cows or calves nursing pregnant cows.	030149	10 Dose	\$22.89	
				030150	50 Dose	\$105.99	
		Express® FP 5 VL5 HB	Bovine Rhinotracheitis-Virus Diarrhea-Parainfluenza3-Respiratory Syncytial Virus Vaccine, Modified Live Virus, Campylobacter Fetus-Leptospira Canicola-Grippotyphosa-Hardjo-Icterohaemorrhagiae-Pomona Bacterin, cows and heifers prior to breeding.	038036	10 Dose	\$35.59	
					038037	50 Dose	\$153.29
	Pyramid® 10 HB	Bovine Rhinotracheitis-Virus Diarrhea-Parainfluenza3-Respiratory Syncytial Virus Vaccine, Modified Live Virus, Leptospira Canicola-Grippotyphosa-Hardjo-Icterohaemorrhagiae-Pomona Bacterin, cattle.	028573	10 Dose	\$25.19		
				028574	50 Dose	\$116.89	
		TrichGuard®	Tritrichomonas Foetus Vaccine, Killed Protozoa, cattle.	010204	10 Dose	\$68.09	
				010203	50 Dose	\$328.99	
Merck		L5 SQ	Leptospira Canicola-Grippotyphosa-Hardjo-Icterohaemorrhagiae-Pomona Bacterin, cattle 6 months and older.	026721	50 Dose	\$72.86	
		Vista® 5 L5 SQ	Bovine Rhinotracheitis-Virus Diarrhea-Parainfluenza3-Respiratory Syncytial Virus Vaccine, Modified Live Virus, Leptospira Canicola-Grippotyphosa-Hardjo-Icterohaemorrhagiae-Pomona Bacterin, cows and heifers prior to breeding.	026812	5 Dose	\$18.24	
					026717	10 Dose	\$24.99
					026718	50 Dose	\$105.59
		Vista® 5 VL5 SQ	Bovine Rhinotracheitis-Virus Diarrhea-Parainfluenza3-Respiratory Syncytial Virus Vaccine, Modified Live Virus, Campylobacter Fetus-Leptospira Canicola-Grippotyphosa-Hardjo-Icterohaemorrhagiae-Pomona Bacterin, cows and heifers prior to breeding.	027421	10 Dose	\$31.29	
				027422	50 Dose	\$140.79	

PRODUCER PROGRAMS — We handle all the paper work and you get to cash the check. Do you qualify for producer rebates? Call us today at 866-438-7541 to find out!



One Shot. Two Ingredients. Fast Recovery.

New Draxxin[®] KP can treat BRD and control fever quickly.^{1,2}

Start treating bovine respiratory disease (BRD) and fever quickly with Draxxin[®] KP (tulathromycin and ketoprofen injection) Injectable Solution. The long-lasting BRD treatment you trust now has added fever control that can help support animal well-being.^{1,2} It's an effective combination that can help your cattle recover from BRD and fever fast, which can help them feel better.*

Learn more at DraxxinKP.com

Draxxin KP
tulathromycin and ketoprofen injection

zoetis

IMPORTANT SAFETY INFORMATION: Draxxin KP has a pre-slaughter withdrawal time of 18 days in cattle. Not for use in female dairy cattle 1 year of age or older, including dry dairy cows. Not for use in beef calves less than 2 months of age, dairy calves, and veal calves. A withdrawal period has not been established for this product in pre-ruminating calves. Do not use in animals previously found to be hypersensitive to tulathromycin and ketoprofen. See full Prescribing Information, attached.

*Draxxin KP retreats showed a numerically improved morbidity and respiratory scores compared with saline-treated and Draxxin-treated animals.
¹Data on File, Study Report No. A437N/US-16-418, Zoetis Inc.
²Data on File, Study Report No. A137N/US-17-529 and Report Amendment 01, Zoetis Inc.
 All trademarks are the property of Zoetis Services LLC or a related company or a licensor unless otherwise noted. © 2021 Zoetis Services LLC. All rights reserved. DPK-00036.

Brief Summary of full Prescribing Information



For subcutaneous injection

Antibiotic: 100 mg of Tulathromycin
Non-Steroidal Anti-inflammatory Drug: 120 mg Ketoprofen

CAUTION: Federal law restricts this drug to use by or on the order of a licensed veterinarian.

DESCRIPTION

DRAXXIN KP (tulathromycin and ketoprofen injection) Injectable Solution is a ready to use sterile preservative free preparation containing tulathromycin, a semi-synthetic macrolide antibiotic of the subclass trimethyl and ketoprofen, a non-steroidal anti-inflammatory drug. **ACTIVE INGREDIENTS:** Each mL of DRAXXIN KP contains 100 mg of tulathromycin as a free base and 120 mg ketoprofen as a free acid in a 50% propylene glycol vehicle. **INACTIVE INGREDIENTS:** monothiolactone (5 mg/mL), 2-pyrrolidone (10 mg/mL), citric acid (10 mg/mL), and sodium hydroxide/hydrochloric acid added to adjust pH. DRAXXIN KP contains an equimolar mixture of two enantiomeric forms of tulathromycin in a 9:1 ratio and a racemic mixture of ketoprofen.

The chemical names of the tulathromycin isomers are (2*S*,3*R*,5*R*,6*R*), 13*R*, 13*S*, 13*S*, 14*R*)-13-[[2,6-dideoxy-3-*C*-methyl-3-*O*-methyl-4-*C*-(*trans*-aminomethyl)-*o*-L-ribo-heptapentose]oxy]-2-ethyl-3,4,10-trihydroxy-3,5,8,11,12,14-hexamethyl-11-(2*S*,4,6-trideoxy-3-*cyanoethylamino*-*D*-ribo-heptapentose)-oxy]-1-*oxo*-4-azacyclotetradecane-1*S*-one and (2*S*,3*R*,5*R*,6*R*), 6*R*, 10*S*, 11*S*, 12*R*)-11-(7*R*-deoxy-3-*C*-methyl-3-*O*-methyl-4-*C*-(*trans*-aminomethyl)-*o*-L-ribo-heptapentose]oxy]-2-ethyl-3,4,10-trihydroxy-3,5,8,11,12,14-hexamethyl-11-(2*S*,4,6-trideoxy-3-*cyanoethylamino*-*D*-ribo-heptapentose)-oxy]-1-*oxo*-4-azacyclotetradecane-1*S*-one, respectively.

The chemical name of ketoprofen is 2-(4-*fluorophenyl*) propionic acid.

INDICATIONS

Draxxin[®] KP is indicated for the treatment of bovine respiratory disease (BRD) associated with Mannheimia haemolytica, Pasteurella multocida, Histophilus somni, and Mycoplasma bovis and control of pyrexia associated with BRD in beef steers, beef heifers, beef calves 2 months of age and older, beef bulls, dairy heifers, and replacement dairy heifers. Not for use in reproducing animals one year of age, dairy calves, or veal calves.

DOSEAGE AND ADMINISTRATION

Inject subcutaneously as a single dose in the neck at a dosage of 2.3 mg tulathromycin and 2 mg ketoprofen/kg (0.1 mL/100 lb bodyweight (BW)). Do not exceed more than 10 mL per injection site. Use this product within 35 days of the first injection and purchase a maximum of 20 doses. If more than 20 injections are anticipated, the use of automatic injection equipment or a syringe with a 10 mL syringe is recommended. When using a dose of 10 mL or more with bore diameter larger than 10 gauge, discard any product remaining in the vial immediately after use.

Table 1. DRAXXIN KP Cattle Dosing Table

Animal Weight (lb)	Dose Volume (mL)
100	1.7
200	2.5
250	2.8
300	3.4
350	4.0
400	4.5
500	5.7
600	6.8
700	8.0
800	9.1
900	10.2
1000	11.4

CONTRAINDICATIONS

The use of DRAXXIN KP Injection is contraindicated in animals previously found to be hypersensitive to tulathromycin and ketoprofen.

WITHDRAWAL PERIODS AND RESIDUE WARNINGS: Cattle must not be slaughtered for human consumption within 18 days following last treatment with this drug product. Not for use in female dairy cattle 1 year of age or older, including dry dairy cows; use in these cattle may cause drug residues in milk and/or in calves born to these cows or heifers. Not for use in beef calves less than 2 months of age, dairy calves, and veal calves. A withdrawal period has not been established for this product in pre-ruminating calves.

USER SAFETY WARNINGS

NOT FOR HUMAN USE. KEEP OUT OF REACH OF CHILDREN.

The Safety Data Sheet (SDS) provides more detailed occupational safety information. To obtain a Safety Data Sheet contact Zoetis Inc. at 1-800-963-6471.

ANIMAL SAFETY WARNINGS AND PRECAUTIONS

The effects of DRAXXIN KP on bovine reproductive performance, pregnancy, and lactation have not been determined. Not for use in reproducing animals one year of age because reproductive ability being has not been established. Administration of tulathromycin and ketoprofen injection may result in injection site swelling that appears the day after treatment and may persist for at least 10 days post-injection. This may result in loss of edible tissue at slaughter. As a class, cycle-dependent respiratory NDAIDs (ketoprofen) may be associated with gastrointestinal, hepatic and renal toxicity. Sensitivity to drug-associated adverse effects varies with the individual patient. Patients at greatest risk for renal toxicity are those that are dehydrated, on concurrent diuretic therapy, or those with renal, cardiovascular, or hepatic dysfunction. Use judiciously when renal impairment or gastric ulceration is suspected.

Since many NDAIDs possess the potential to induce gastrointestinal ulceration, concurrent use of DRAXXIN KP with other anti-inflammatory drugs, such as other NDAIDs and corticosteroids, should be avoided or closely monitored.

Discontinue use if fluid blood is observed.

ADVERSE REACTIONS

Repeated administration of NDAIDs can result in gastric or renal toxicity. Sensitivity to drug-associated adverse effects varies with the individual patient. Patients at greatest risk for toxicity are those that are dehydrated, on concurrent diuretic therapy, or those with pre-existing gastric ulcers, renal, cardiovascular, and/or hepatic dysfunction.

HOW SUPPLIED

DRAXXIN KP Injection is available in the following package sizes: 30 mL vial, 100 mL vial, 250 mL vial, 500 mL vial

STORAGE CONDITIONS

Store at or below 25°C (77°F), with excursions up to 40°C (104°F).

Protect from freezing.

APPROVED BY FDA under NADA # 141-563.











zoetis

Distributed by:
Zoetis Inc.
Kalamazoo, MI 49001
Product of Spain

May 2021
40000764000007640000076400000000











Reproductive Vaccines

	PRODUCT	DESCRIPTION	ITEM#	SIZE	PRICE	
Elanco		Lepto Shield™ 5	Leptospira Canicola-Grippotyphosa-Hardjo-Icterohaemorrhagiae-Pomona Bacterin, cattle and swine.	027879	10 Dose	CALL FOR BEST DETYE PRICING
				001336	50 Dose	
		Vib Shield® Plus L5	Campylobacter Fetus-Leptospira Canicola-Grippotyphosa-Hardjo-Icterohaemorrhagiae-Pomona Bacterin, cattle.	011030	10 Dose	
				011031	50 Dose	
		Vira Shield® 4+VL5	Bovine Rhinotracheitis-Virus Diarrhea Vaccine, Killed Virus, Campylobacter Fetus-Leptospira Canicola-Grippotyphosa-Hardjo-Icterohaemorrhagiae-Pomona Bacterin, breeding cattle, including pregnant cows and heifers. Adjuvanted with Xtend® SP. Contains amphotericin B, gentamicin and thimerosal as preservatives.	013822	50 Dose	
		Vira Shield® 6+L5	Bovine Rhinotracheitis-Virus Diarrhea-Parainfluenza3-Respiratory Syncytial Virus Vaccine, Killed Virus, Leptospira Canicola-Grippotyphosa-Hardjo-Icterohaemorrhagiae-Pomona Bacterin, breeding cattle, including pregnant cows and heifers. Adjuvanted with Xtend® SP. Contains amphotericin B, gentamicin and thimerosal as preservatives.	026311	10 Dose	
				026312	50 Dose	
		Vira Shield® 6+L5 HB	Bovine Rhinotracheitis-Virus Diarrhea-Parainfluenza3-Respiratory Syncytial Virus Vaccine, Killed Virus, Leptospira Canicola-Grippotyphosa-Hardjo-Icterohaemorrhagiae-Pomona Bacterin, cattle, including pregnant cows and heifers. Adjuvanted with Xtend® SP. Contains amphotericin B, gentamicin and thimerosal as preservatives.	027158	10 Dose	
				027159	50 Dose	
		Vira Shield® 6+L5 HB Somnus	Bovine Rhinotracheitis-Virus Diarrhea-Parainfluenza3-Respiratory Syncytial Virus Vaccine, Killed Virus, Haemophilus Somnus-Leptospira Canicola-Grippotyphosa-Hardjo-Icterohaemorrhagiae-Pomona Bacterin, cattle 3 months or older (including pregnant cows and heifers). Adjuvanted with Xtend® SP. Contains amphotericin B, gentamicin and thimerosal as preservatives.	027161	50 Dose	
		Vira Shield® 6+VL5	Bovine Rhinotracheitis-Virus Diarrhea-Parainfluenza3-Respiratory Syncytial Virus Vaccine, Killed Virus, Campylobacter Fetus-Leptospira Canicola-Grippotyphosa-Hardjo-Icterohaemorrhagiae-Pomona Bacterin, breeding cattle, including pregnant cows and heifers. Adjuvanted with Xtend® SP. Contains amphotericin B, gentamicin and thimerosal as preservatives.	026313	10 Dose	
				026314	50 Dose	
		Vira Shield® 6+VL5 HB	Bovine Rhinotracheitis-Virus Diarrhea-Parainfluenza3-Respiratory Syncytial Virus Vaccine, Killed Virus, Campylobacter Fetus-Leptospira Canicola-Grippotyphosa-Hardjo-Icterohaemorrhagiae-Pomona Bacterin, breeding cattle, including pregnant cows and heifers. Adjuvanted with Xtend® SP. Contains amphotericin B, gentamicin and thimerosal as preservatives.	028719	10 Dose	
				028720	50 Dose	
		Vira Shield® 6+VL5 HB Somnus	Bovine Rhinotracheitis-Virus Diarrhea-Parainfluenza3-Respiratory Syncytial Virus Vaccine, Killed Virus, Campylobacter Fetus-Haemophilus Somnus-Leptospira Canicola-Grippotyphosa-Hardjo-Icterohaemorrhagiae-Pomona Bacterin, breeding cattle, including pregnant cows and heifers. Adjuvanted with Xtend® SP. Contains amphotericin B, gentamicin and thimerosal as preservatives.	028721	10 Dose	
				028722	50 Dose	
	Vira Shield® 6+VL5 Somnus	Bovine Rhinotracheitis-Virus Diarrhea-Parainfluenza3-Respiratory Syncytial Virus Vaccine, Killed Virus, Campylobacter Fetus-Haemophilus Somnus-Leptospira Canicola-Grippotyphosa-Hardjo-Icterohaemorrhagiae-Pomona Bacterin, breeding cattle, including pregnant cows and heifers. Adjuvanted with Xtend® SP. Contains amphotericin B, gentamicin and thimerosal as preservatives.	026315	10 Dose		
			026316	50 Dose		

* Product shortages have restricted our ability to present accurate pricing on some products. As always, we work hard to offer you the best price. Please call for best pricing.

Reproductive Vaccines

	PRODUCT	DESCRIPTION	ITEM#	SIZE	PRICE	
Zoetis		Bovi-Shield® GOLD FP® 5	Bovine Rhinotracheitis-Virus Diarrhea-Parainfluenza3-Respiratory Syncytial Virus Vaccine, Modified Live Virus, cows and heifers prior to breeding.	027120	10 Dose	\$19.70
				027121	50 Dose	\$88.06
		Bovi-Shield® GOLD FP® 5 L5	Bovine Rhinotracheitis-Virus Diarrhea-Parainfluenza3-Respiratory Syncytial Virus Vaccine, Modified Live Virus - Leptospira Canicola-Grippotyphosa-Hardjo-Icterohaemorrhagiae-Pomona Bacterin, cows and heifers prior to breeding.	022492	5 Dose	\$13.99
				022493	10 Dose	\$25.64
				022494	50 Dose	\$113.72
		Bovi-Shield® GOLD FP® 5 VL5	Bovine Rhinotracheitis-Virus Diarrhea-Parainfluenza3-Respiratory Syncytial Virus Vaccine, Modified Live Virus - Campylobacter Fetus-Leptospira Canicola-Grippotyphosa-Hardjo-Icterohaemorrhagiae-Pomona Bacterin, cows and heifers prior to breeding.	022495	10 Dose	\$33.64
				022496	50 Dose	\$151.84
		CattleMaster® 4+VL5	Bovine Rhinotracheitis-Virus Diarrhea-Parainfluenza3-Respiratory Syncytial Virus Vaccine, Modified Live and Killed Virus-Campylobacter Fetus-Leptospira Canicola-Grippotyphosa-Hardjo-Icterohaemorrhagiae-Pomona Bacterin, cattle (including pregnant cows).	008852	10 Dose	\$45.38
				008853	25 Dose	\$110.54
		CattleMaster® GOLD FP™ 5	Bovine Rhinotracheitis-Virus Diarrhea-Parainfluenza3-Respiratory Syncytial Virus Vaccine, Modified Live and Killed Virus, cattle (including pregnant cows).	023938	5 Dose	\$18.34
				023939	10 Dose	\$34.49
				023940	25 Dose	\$82.81
		CattleMaster® GOLD FP™ 5 L5	Bovine Rhinotracheitis-Virus Diarrhea-Parainfluenza3-Respiratory Syncytial Virus Vaccine, Modified Live and Killed Virus, Leptospira Canicola-Grippotyphosa-Hardjo-Icterohaemorrhagiae-Pomona Bacterin, cattle (including pregnant cows).	023941	5 Dose	\$21.68
				023942	10 Dose	\$38.53
				023943	25 Dose	\$93.82
		Leptoferm-5®	Leptospira Canicola-Grippotyphosa-Hardjo-Icterohaemorrhagiae-Pomona Bacterin, cattle and swine.	000699	10 Dose	\$8.33
				000700	50 Dose	\$37.37
		PregGuard® GOLD FP® 10	Bovine Rhinotracheitis-Virus Diarrhea-Parainfluenza3 Vaccine, Modified Live Virus, Campylobacter Fetus-Leptospira Canicola-Grippotyphosa-Hardjo-Icterohaemorrhagiae-Pomona Bacterin, cattle.	022497	10 Dose	\$25.53
				022498	50 Dose	\$114.51
	Protivity	Protivity Vaccine has been shown to be effective for the vaccination of healthy cattle 1 week of age or older against respiratory disease caused by Mycoplasma bovis. Duration of immunity has not been established. See package insert for complete product details.	117816	10 Dose	\$28.83	
			117817	50 Dose	\$138.63	
	Spirovac® L5	Leptospira Canicola-Grippotyphosa-Hardjo-Icterohaemorrhagiae-Pomona Bacterin, cattle.	024148	10 Dose	\$44.03	
			024149	50 Dose	\$221.63	
	Spirovac® VL5	Campylobacter Fetus-Leptospira Canicola-Grippotyphosa-Hardjo-Icterohaemorrhagiae-Pomona Bacterin, cattle.	023944	10 Dose	\$32.11	
			023945	50 Dose	\$156.48	
	Spirovac™	Leptospira Hardjo Bacterin, cattle.	021784	10 Dose	\$40.42	
			021785	50 Dose	\$205.39	

DO YOU QUALIFY FOR PREMIER PRICING?
CALL US TO FIND OUT.



Respiratory Vaccines

	PRODUCT	DESCRIPTION	ITEM#	SIZE	PRICE	
Huvepharma	Myco-B	Myco-B one dose mycoplasma	064956	10 Dose	\$51.49	
			064957	50 Dose	\$257.39	
Boehringer Ingelheim	Bar Somnus 2P™	Haemophilus Somnus-Mannheimia Haemolytica-Pasteurella Multocida Bacterin, cattle.		10 Dose	\$19.39	
			001166	50 Dose	\$87.99	
		Express® 5	Bovine Rhinotracheitis-Virus Diarrhea-Parainfluenza3-Respiratory Syncytial Virus Vaccine, Modified Live Virus, cattle.	019104	10 Dose	\$17.59
				019105	50 Dose	\$78.69
		Express® 5-HS	Bovine Rhinotracheitis-Virus Diarrhea-Parainfluenza3-Respiratory Syncytial Virus Vaccine, Modified Live Virus, Haemophilus Somnus Bacterin, cattle.	019583	10 Dose	\$24.39
				019584	50 Dose	\$113.89
		Presponse® HM	Pasteurella Multocida Bacterial Extract-Mannheimia Haemolytica Toxoid, dairy and beef cattle 7 months and older.	012783	10 Dose	\$44.69
				012784	50 Dose	\$185.09
		Presponse® SQ	Mannheimia Haemolytica Toxoid, adjuvanted, dairy and beef cattle 3 months and older. Contains thimerosal as a preservative.	011654	10 Dose	\$38.19
				011655	50 Dose	\$173.19
		Pyramid® 5	Bovine Rhinotracheitis-Virus Diarrhea-Parainfluenza3-Respiratory Syncytial Virus Vaccine, Modified Live Virus, cattle.	022731	10 Dose	\$17.19
				022732	50 Dose	\$77.19
	Pyramid® 5 + Presponse® SQ	Bovine Rhinotracheitis-Virus Diarrhea-Parainfluenza3-Respiratory Syncytial Virus Vaccine, Modified Live Virus, Mannheimia Haemolytica Toxoid, cattle.	030212	10 Dose	\$46.39	
			030213	50 Dose	\$222.99	
	Triangle® 4 + PH-K	Bovine Rhinotracheitis-Virus Diarrhea-Parainfluenza3-Respiratory Syncytial Virus Vaccine, Killed Virus, Mannheimia Haemolytica Bacterin, cattle.	003947	10 Dose	\$70.29	
			003943	50 Dose	\$340.89	
	Triangle® 5	Bovine Rhinotracheitis-Virus Diarrhea-Parainfluenza3-Respiratory Syncytial Virus Vaccine, Killed Virus, cattle.	017578	10 Dose	\$30.00	
			017579	50 Dose	\$138.39	
Elanco	Titanium 5	IBR, BVD Types I and II, PI3 and BRSV. Give 2 ml SQ or IM. For primary vaccination, booster with BRSV in 2-4 weeks. Calves vaccinated before weaning should be revaccinated 30 days after weaning. Annual booster is recommended. Modified live, requires mixing. Do not use in pregnant cows or calves nursing pregnant cows.		10 Dose	CALL FOR BEST DETYE PRICING	
				50 Dose		

* Product shortages have restricted our ability to present accurate pricing on some products. As always, we work hard to offer you the best price. Please call for best pricing.

DISCLAIMER

Because of ever-changing market prices & manufacturers programs, prices are subject to change without notice. You will be notified of all possible savings programs & price breaks to the best of our ability. We encourage you to call to discuss a program that would best fit your needs.

Because of the possibility of typographical or human error, DeTye disclaims responsibility for errors. DeTye also disclaims any responsibility for the use or misuse of products & the methods of use described in this catalog. The manufacturers label should always be followed. Purchasers & users should always follow their veterinarians recommendations.

Cattle First.

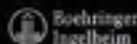

PYRAMID
+ PRESPONSE SQ

PYRAMID
+ **PRESPONSE** SQ

RELENTLESS PROTECTION

PUT GREAT IN, GET GREAT OUT.

On a beef operation, risk is everywhere. And calf health is everything. Invest in your herd's future by using a calf vaccine as premier as your calves: Pyramid[®] + Presponse[®] SQ. It's proven by recent research to defend against the primary viruses and bacteria that lead to bovine respiratory disease — like BVDV Type 1b, BRSV and Mannheimia haemolytica — even in the face of maternal antibodies.

PYRAMIDVaccines.com

PYRAMID[®], the PYRAMID Logo[®] and PRESPONSE[®] are registered trademarks of Boehringer Ingelheim Animal Health USA Inc.
©2019 Boehringer Ingelheim Animal Health USA Inc., Duluth, GA. All Rights Reserved. L19-BOV-0230-0000A







Respiratory Vaccines

* BO, Backordered



	PRODUCT	DESCRIPTION	ITEM#	SIZE	PRICE	
Merck		Nasalgen® IP	Bovine Rhinotracheitis-Parainfluenza3 Vaccine, cattle 5 months and older.	000786	10 Dose	\$14.29
				000787	50 Dose	\$55.11
		Nasalgen® 3	1 week of age or older against infectious bovine rhinotracheitis (IBR) virus, bovine respiratory syncytial virus (BRSV) and parainfluenza 3 virus (PI3). Duration of immunity against IBR is at least 195 days, against BRSV is at least 78 days, and against PI3 is at least 95 days.		10 Dose	\$21.45
					25 X 1 Dose	\$67.79
					50 Dose	\$82.34
		Nasalgen® 3 PMH	1 week of age or older against infectious Bovine Rhinotracheitis (IBR) virus, Bovine Respiratory Syncytial Virus (BRSV), Parainfluenza 3 virus (PI3), Mannheimia haemolytica and Pasteurella multocida.		10 Dose	\$42.99
					25 X 1 Dose	\$141.90
					50 Dose	\$205.99
		Once PMH® IN	For the vaccination of healthy cattle, 1 week of age or older, as an aid in the control of respiratory disease caused by Mannheimiahaemolytica and as an aid in the prevention of disease caused by Pasteurella multocida.	050409	10 Dose	\$42.11
				050412	50 Dose	\$192.35
		Once PMH® SQ	Mannheimia Haemolytica-Pasteurella Multocida Bacterin, Avirulent Live Culture, cattle 3 months and older.	026719	10 Dose	\$42.12
				026720	50 Dose	\$192.35
		Vista™ 5 SQ	Bovine Rhinotracheitis-Virus Diarrhea-Parainfluenza3-Respiratory Syncytial Virus Vaccine, Modified Live Virus, nonpregnant cattle 3 months and older.	026714	10 Dose	\$19.12
				026715	50 Dose	\$80.57
	Vista™ BVD	3 months of age or older against respiratory disease and fetal infection, including persistently infected calves due to bovine virus diarrhea virus (BVD) Types 1 & 2. Respiratory duration of immunity is at least 1 year and reproductive duration of immunity is at least 206 days		10 Dose	\$15.28	
				50 Dose	\$36.34	
	Vista™ Once SQ	Bovine Rhinotracheitis-Virus Diarrhea-Parainfluenza3-Respiratory Syncytial Virus-Mannheimia Haemolytica-Pasteurella Multocida Vaccine, Modified Live Virus-Avirulent Live Culture, cattle 3 months and older.	026764	10 Dose	\$51.99	
			026765	50 Dose	\$233.99	
Elanco		Nuplura PH	Mannheimia Haemolytica Bacterial Extract-Toxoid, adjuvanted with Emulsigen® D, cattle 3 months and older. Preservatives: Thimerosal and gentamicin. Do not vaccinate within 60 days before slaughter.	040078	10 Dose	CALL FOR BEST DETYE PRICING
				040079	50 Dose	
		Somnu Shield™	Haemophilus Somnus Bacterin, cattle.	009082	50 Dose	
					Vira Shield® 6	
	023896	50 Dose				
		Vira Shield® 6+Somnus	Bovine Rhinotracheitis-Virus Diarrhea-Parainfluenza3-Respiratory Syncytial Virus Vaccine, Killed Virus, Haemophilus Somnus Bacterin, cattle 3 months or older (including pregnant cows and heifers). Adjuvanted with Xtend® SP. Contains amphotericin B, gentamicin, and thimerosal as preservatives.	023894	10 Dose	
				023893	50 Dose	

* Product shortages have restricted our ability to present accurate pricing on some products. As always, we work hard to offer you the best price. Please call for best pricing.



	PRODUCT	DESCRIPTION	ITEM#	SIZE	PRICE	
Zoetis		Bovi-Shield® GOLD 5	Bovine Rhinotracheitis-Virus Diarrhea-Parainfluenza3-Respiratory Syncytial Virus Vaccine, Modified Live Virus, cattle.	022489	5 Dose	\$9.93
				022490	10 Dose	\$18.73
				022491	50 Dose	\$81.39
		Bovi-Shield® GOLD BVD	For vaccination of healthy cattle to prevent viremia caused by bovine virus diarrhea (BVD) virus Types 1 and 2, and as an aid in preventing respiratory disease caused by (BVD) Types 1 and 2 viruses		10 Dose	\$6.34
					50 Dose	\$25.99
		Bovi-Shield Gold One Shot	A combination vaccine for healthy cattle to prevent respiratory disease caused by infectious bovine rhinotracheitis (IBR) virus and (BVD) Types 1 and 2 viruses; parainfluenza 3 (PI ₃) virus, bovine respiratory syncytial virus (BRSV) and bovine pneumonia caused by M. (pasteurella) haemolytica Type A1.		10 Dose	\$51.00
					50 Dose	\$247.57
		Inforce™ 3	The first and only respiratory vaccine that prevents respiratory disease cause by BRSV, while also aiding in the prevention of IBR and PI3, to help get cattle off to a healthier, more productive start.		Single 25 count x 1	\$2.71
					10 Dose	\$19.50
					25 Dose	\$47.69
					50 Dose	\$82.81



Respiratory Vaccines

		PRODUCT	DESCRIPTION	ITEM#	SIZE	PRICE
Zoetis		One Shot Ultra™ 7	Clostridium Chauvoei-Septicum-Novyi-Sordellii-Perfringens Types C & D-Pasteurella Haemolytica Bacterin-Toxoid, cattle.	017957	10 Dose	\$46.08
				017961	50 Dose	\$224.15
		One Shot®	Pasteurella Haemolytica Bacterin-Toxoid, freeze-dried, cattle.	019026	5 Dose	\$22.67
				006329	10 Dose	\$37.42
				004796	50 Dose	\$179.11
		Somubac®	Haemophilus Somnus Bacterin, cattle and calves.	017962	10 Dose	\$7.67
017971				50 Dose	\$33.10	

Scours Vaccines

		PRODUCT	DESCRIPTION	ITEM#	SIZE	PRICE
Elanco		Bovine Pili Shield™	Escherichia Coli Bacterin, heifers and cows.	013952	20 Dose	CALL FOR BEST DETYE PRICING
				006716	100 Dose	
		Bovine Pili Shield™ +C	Clostridium Perfringens Type C-Escherichia Coli Bacterin-Toxoid, pregnant cattle.	019762	20 Dose	
				019739	100 Dose	
		Scour Bos® 4	Bovine Rota-Coronavirus Vaccine, Killed Virus, pregnant cattle.	019763	10 Dose	
				019580	50 Dose	
	Scour Bos® 9	Bovine Rota-Coronavirus Vaccine, Killed Virus, Clostridium Perfringens Type C-Escherichia Coli Bacterin-Toxoid, pregnant cattle.	019681	10 Dose		
			019680	50 Dose		
Zoetis		Calf-Guard®	Bovine Rota-Coronavirus Vaccine, Modified Live Virus, newborn calves and pregnant cows.	005889	Single 25 x 1 Dose	\$5.06
		ScourGuard 4® (K)/C	Bovine Rota-Coronavirus Vaccine, Killed Virus, Clostridium Perfringens Type C-Escherichia Coli Bacterin-Toxoid, pregnant cows and first-calf heifers.	028801	10 Dose	\$63.43
				028802	50 Dose	\$295.59
		ScourGuard® 4K	Bovine Rota-Coronavirus Vaccine, Killed Virus, Escherichia Coli Bacterin, pregnant cows and heifers.	028799	10 Dose	\$64.70
028800				50 Dose	\$301.83	
Merck		Guardian®	Bovine Rotavirus-Coronavirus Vaccine, Killed Virus, Clostridium Perfringens Types C & D-Escherichia Coli Bacterin-Toxoid, pregnant cattle.	024061	10 Dose	\$59.39
				024062	50 Dose	\$287.88

* Product shortages have restricted our ability to present accurate pricing on some products. As always, we work hard to offer you the best price. Please call for best pricing.



Elanco

YOUR BEST LINE OF DEFENSE.

The #1 Pour-On dewormer in the industry doesn't play games.¹ Internal parasites can do a real number on your herd and your operation's bottom line. Without dewormers, cow-calf producers can sacrifice more than \$165 per head in lost returns.² Settle the score before they cost you with Cydectin® (moxidectin) Pour-On or Cydectin® (moxidectin) Injectable. Cydectin delivers persistent control of costly parasites without posing a risk to environmentally beneficial dung beetles and earthworms.^{3,4}

CydectinBeef.com



CYDECTIN®
(moxidectin)

Keep Cydectin Out of Reach of Children.

¹ Elanco Animal Health, Data on File.

² Lawrence, J., Ibarburi, M. 2007. "Economic analysis of pharmaceutical technologies in modern beef production." Proceedings, NCCC-134 Conference on Applied Commodity Price Analysis, Forecasting, and Market Risk Management, 10.

³ Suarez, V., Lifschitz, A., Sallowitz, J., et al. 2009. "Effects of faecal residues of moxidectin and doramectin on the activity of arthropods in cattle dung." ScienceDiet.72:1551-1558.

⁴ Environmental Assessment, Cydectin® moxidectin 0.5% Pour-On for Cattle. Fort Dodge Animal Health, June 1997.

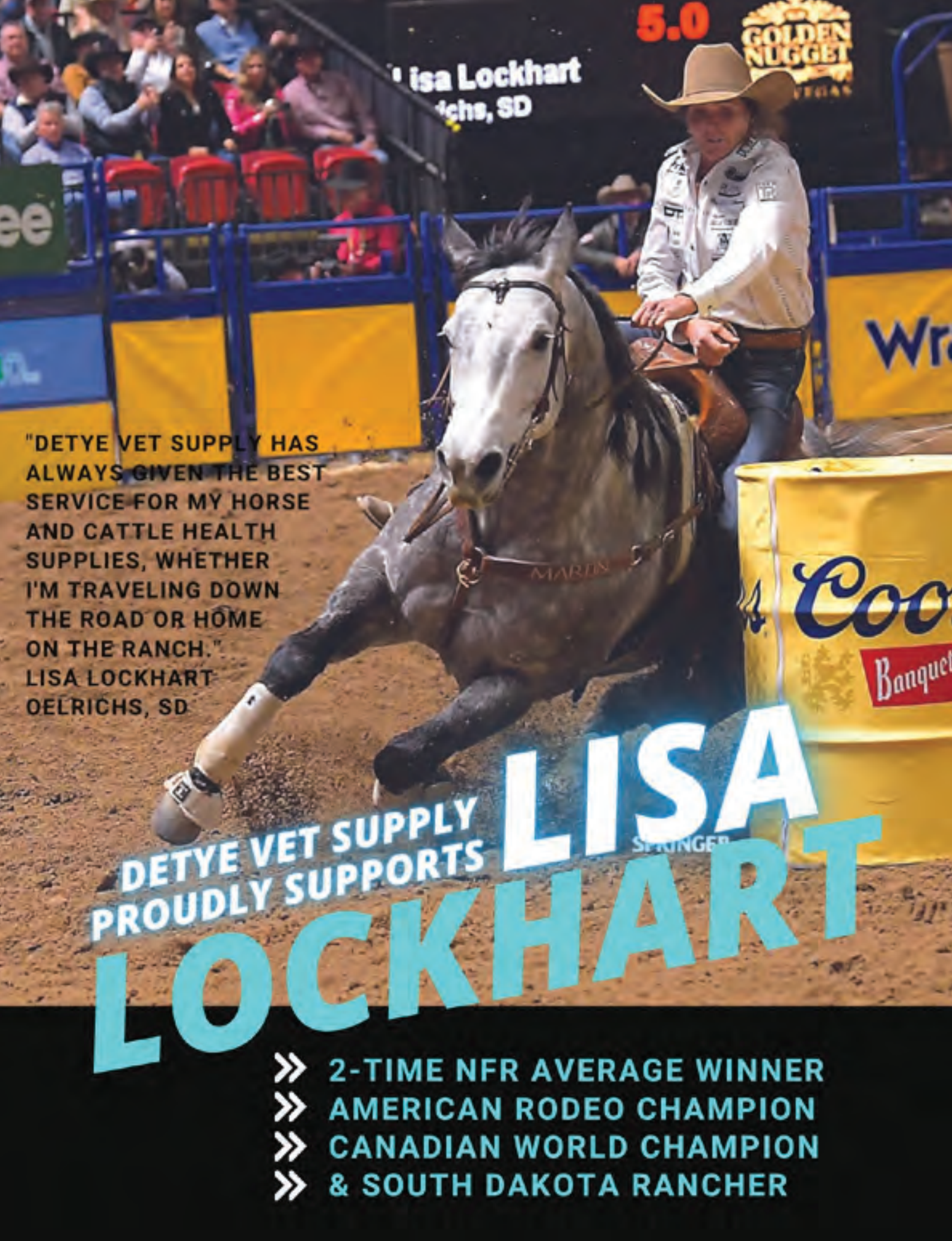

Lisa Lockhart
DelRichts, SD

5.0

GOLDEN NUGGET
VEGAS

"DETYE VET SUPPLY HAS ALWAYS GIVEN THE BEST SERVICE FOR MY HORSE AND CATTLE HEALTH SUPPLIES, WHETHER I'M TRAVELING DOWN THE ROAD OR HOME ON THE RANCH."
LISA LOCKHART
DELRIEHS, SD

DETYE VET SUPPLY PROUDLY SUPPORTS **LISA LOCKHART**

- » 2-TIME NFR AVERAGE WINNER
- » AMERICAN RODEO CHAMPION
- » CANADIAN WORLD CHAMPION
- » & SOUTH DAKOTA RANCHER

Sometimes You Don't Get a Second Chance

The first 24-Hours of life are the most important for development, vitality and growth potential.

Calf Start protects your calves with 5 antibody strains, microbials and essential vitamins A, D and Natural E.



• CALF START WORKS IN 3 MAIN WAYS •



- 1) Antibodies that support the immune system to defend against common disease causing pathogens.
- 2) Support the development of the GI tract through healthy bacterial population growth.
- 3) Vitamins A and D for Immune and Growth Support. Natural Vitamin E for immune function, muscle development, and antioxidant support.



Sometimes You Do

If your calves get GI disease or stress up until weaning, having Calf Recover on hand is the quickest way to boost their immunity and get them back to gaining.

• CALF RECOVER IS A 6-IN-1 PRODUCT •

- 1) Antibodies for immune support - immunoglobulins
- 2) Saccharomyces boulardii - Potent in preventing diarrhea, gut inflammation, and pathogen overgrowth.
- 3) Probiotic Stack for microbiome development – Saccharomyces cerevisiae
- 4) L-glutamine - Intestinal Health: maintain the integrity of the intestinal mucosa. Primary energy source for enterocytes (intestinal cells).
- 5) Prebiotic – Essential food for good microbes and natural diversity.
- 6) Digestive Enzymes – Break down milk sugars.



L&H Branding Irons

	PRODUCT	PRICE		PRODUCT	PRICE
	Hot Knife	\$161		Number Brander Horizontal, 2"-4" set of 3	\$490
	Freeze Brander, 4" number set	\$310		Number Brander Vertical, 2"-4" set of 3	\$490
	Freeze Brander, 5" number set	\$460			
	Freeze Brander, 6" number set	\$467			
	Custom Fire Heated Brander, 1 or 2 character	\$167		Paint Brander, 2 1/2"	\$76
	Custom Fire Heated Brander, 3 or 4 character	\$188		Paint Brander, 4"	\$84
	All Purpose Brander	\$172		Searing Iron Brander-Dehorns	\$114
	Individual Letters	\$8.25			
	Set of Letters A-Z	\$212			
	Set of Numbers 0-9	\$86			
	Electric Brander, Single letter or figure	\$175		Semi-Universal Brander-Dehorns	\$94
	Electric Brander, 2 letters or figures	\$185			
	Electric Brander, 3 letters or figures	\$195			
	Propane Heater, Model 15H	\$420		Stainless Steel # Sets	
	Propane Heater, Model 30H	\$465		2 inch	\$258
				3 inch	\$285
				3 1/2 inch	\$290
				4 inch	\$315
		5 inch	\$322		
			Universal Brander, 2"-4"	\$111	

Drenchers, Feeders & Oral Dosers



Large Drench Syringe (Jorgensen)

This drench syringe allows you to administer large doses often necessary to treat adult cattle. The use of oral calcium or propylene glycol drenches are easier with a large drencher.

- Curved nozzle with olive tip
- Clear barrel to see medication
- High-impact plastic handle

ITEM#	Description	Size	Price
023213	Large Drench Syringe	300cc	\$120.09



Fluidfeeder (Springer Magrath)

This durable feeder is available in a variety of configurations with interchangeable components. Permits one-handed administration of colostrum and life-saving fluids to newborn calves.

ITEM#	Description	Size	Price
031772	Fluidfeeder with Plastic Probe	2 Quart	\$22.39
021186	Fluidfeeder with Plastic Probe	Gallon	\$35.89



Oral Calf Feeder with Probe (VetOne)

This is an easy-to-use device for rehydrating scouring calves. The clear collapsible bag, with graduated markings from 500 mL to 2500 mL, has a large handle for carrying and hanging. Zippered opening allows for easy filling and cleaning. Features a 17" rigid probe with a rounded end that is designed for easy introduction into the esophagus, preventing tracheal introduction. Clear tubing is approximately 33" long. Convenient on/off flow clamp included. The 17" flexible replacement probe comes with 33" clear tubing, barbed adapter for easy attachment, and on/off clamp.

ITEM#	Description	Size	Price
602028	Oral Calf Feeder with Probe	2.5 liter	\$23.69
614028	Replacement Probe with Tubing	17" L	\$10.59



Balling Guns, Metal

ITEM#	Description	Length	Mfr.	Price
010219	Metal Balling Gun, spring clips, 2-3/8" steel head (1" diameter)	16"	Ideal Instruments	\$23.39



Balling Guns, Plastic

ITEM#	Description	Mfr.	Price
004901	Balling Gun, Calf, Blue	Jorgensen	\$4.99
007272	Balling Gun, Calf, White	Jorgensen	\$4.99
008097	Balling Gun, Cow, Red	Jorgensen	\$4.99
018117	Balling Gun, Brown, for Terramycin	Pfizer	\$4.99

Automatic Syringes



Vaccinators (Prima Tech)

- Patented spring tensioner allows you to tune the applicator for use with a wide range of products
- Vaccinators of all sizes have a steel needle nib (patent pending), making them stronger and more durable to avoid expensive downtime due to equipment failure
- Ergonomic handle design makes all vaccinators easier and more comfortable to use due to the optimal stroke length
- Vaccinators of all sizes have a "Universal" needle nut that will securely accept all luer spec needles

ITEM#	Description	Price
022681	2cc Replacement Barrel with Silicone O-Ring	\$16.69
021585	5cc Replacement Barrel with Silicone O-Ring	\$17.29
021586	5cc Replacement Piston Viton O-Ring	\$2.99



Bottle-Mount Vaccinators (Prima Tech)

ITEM#	Description	Price
021081	2cc Adjustable Dose with Fast-Fit (fits most 100 mL)	\$52.39
021083	5cc Adjustable Dose with Fast-Fit (fits most 100 mL)	\$51.29
021856	5cc Replacement Barrel with Silicone O-Ring	\$15.49
021080	12.5cc Adjustable Dose with Both Draw-offs	\$51.59



Injector (Prima Tech)

ITEM#	Description	Price
022804	2cc Adjustable Dose with Both Draw-offs	\$49.89
021079	5cc Adjustable Dose with Both Draw-offs	\$49.89



SLAP-SHOT FLEXIBLE VACCINATOR (Slap-Shot Co. Inc.)

ITEM#	Description	Price
	30" syringe extension tube	\$15.19

Automatic Syringes

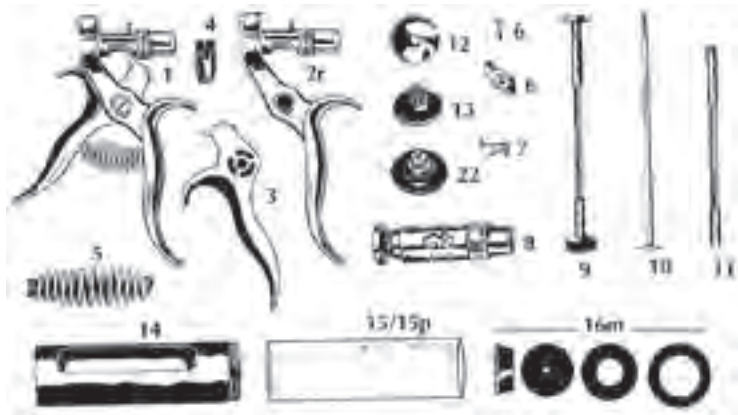
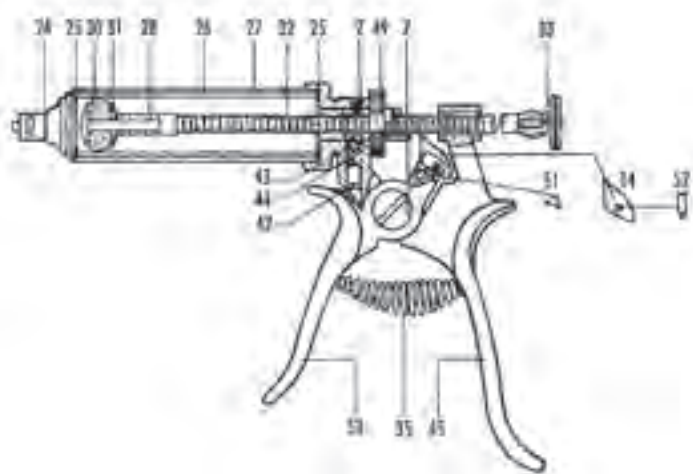

Henke Roux Revolver (Jorgensen)

The Henke Roux is a high-quality precision-made revolver syringe. It comes from Germany and is known for its accuracy. The dosage is set by turning the dosage setting wheel at the rear of the barrel. The 50cc size adjusts to 1, 2, 3, 4, and 5cc doses. (30cc and 10cc sizes available as special order items.)

ITEM#	Description	Price
050532	Henke Roux Revolver, 50cc	\$76.99
Mfr.# J53D2	2 - Dosage wheel screw	
001644	7 - Large handle connecting screw	
004623	14 - Ratchet tip	
003791	24 - Front end with luer lock	
001077	25 - Washer set for glass barrel	
001075	26 - Glass barrel: 50cc	
001076	26p - Plastic barrel: 50cc	
001650	27 - Metal frame for glass barrel: 50cc	
001084	28 - Inner rod: 50cc	
001079	30 - Rubber piston	
001080	31 - Piston holding disc	
002406	32 - Outer rod with ratchet teeth: 50cc	
002397	33 - Knurled knob	
001646	35 - Coil spring for handles	
Mfr.# J53D42	42 - Set screw	
Mfr.# J53D43	43 - Steel ball, 4 mm	
Mfr.# J53D44	44 - Compression spring	
Mfr.# J53D45	45 - Rear handle, complete	
Mfr.# J53D49	49 - Dosage wheel	
002353	51 - Ratchet clip	
002499	52 - Ratchet screw	
Mfr.# J53D53	53 - Complete forward handle	

Hauptner Syringe (Jorgensen)

Famous for accuracy and correct dosing. The 50cc size adjusts to 1, 2, 3, 4, and 5cc doses. (30cc, 25cc, and 10cc sizes available as special order items.)

ITEM#	Description	Price
000578	Hauptner Syringe, 50cc	\$147.19
Mfr.# J31D1	1 - Complete grip	
Mfr.# J31D1D	1d - Adapter needed for 10cc or 25cc only	
Mfr.# J31D2	2 - Grip part less dosage sleeve	
Mfr.# J31D2R	2r - Grip part with dosage sleeve	
Mfr.# J31D3	3 - Grip part with ratchet *	
Mfr.# J31D4	4 - Locking screw *	
001599	5 - Spring for grips *	
003221	6 - Ratchet with screw *	
003222	7 - Small ratchet spring *	
Mfr.# J31D8	8 - Dosage sleeve, separate	
Mfr.# J31D9	9 - Complete plunger rod: 10, 30, 50, or 25cc	
000583	10 - Inner plunger rod: 50cc	
000584	11 - Outer plunger rod: 50cc	
006839	12 - Small plate for plunger	
001598	13 - Tension screw *	
000580	14 - Metal cover for glass barrel: 50cc	
000579	15 - Glass barrel: 50cc	
001600	15p - Plastic barrel: 50cc	
000581	16m - Washer set (includes 16, 17, 18)	
001596	22 - End plate with luer lock	

* Interchangeable with 50, 30, and 25cc Hauptner syringes



Automatic Syringes



Datamars Semi-Automatic Repeater Syringe

- Plastic

ITEM#	Description	Price
043864	50cc	\$76.99
043865	25cc	\$76.99

25MR2/50MR2 Repeater Syringe (Allflex)

- 25 mL and 50 mL volume repeater syringe
- Accurately delivers selected dose
- 25MR2 adjustable dosage from 0.5 mL to 2.5 mL
- 50MR2 adjustable dosage from 1 mL to 5 mL
- Metal handle with textured non-slip coating
- Easy-grip for high-volume use
- Streamlined design with fewer replacement parts
- Barrel and needle attachment are fully autoclavable
- Amber-colored barrel reduces UV exposure
- Color knob pack available to differentiate between medications

ITEM#	Description	Price
010009	25MR2 Draw-Off Injection Syringe	\$106.29
003623	50MR2 Draw-Off Injection Syringe	\$108.89
010012	25MR2 Repair Kit	\$18.99
003911	50MR2 Repair Kit	\$18.99
022699	25MR2 Piston O-Ring	\$3.99
007454	50MR2 Piston O-Ring	\$3.99



2EM/5EM Automatic Syringe (Allflex)

- 2 mL and 5 mL sizes available
- Automatic self-filling tube feed
- 2EM adjustable dosage from 0.25 mL to 2 mL
- 5EM adjustable dosage from 0.5 mL to 5 mL
- Removable barrel for cleaning
- Durable plastic design
- Easy V-grip for high-volume use
- Metal luer lock tip
- Amber-colored barrel reduces UV exposure

ITEM#	Description	Price
026660	2EM Draw-Off Injection Syringe	\$31.49
023338	5EM Draw-Off Injection Syringe	\$31.49
026899	5EM Top Bottle Syringe	\$33.19



2EM-BT Bottle Top Syringe (Allflex)

- Adjustable dosage, 0.25 mL to 2 mL
- Automatic self-filling with bottle attachment
- Heavy-duty bottle cage for bottle protection (50 mL and 100 mL bottles only)
- Accurately delivers selected dose
- Easy V-grip for high-volume use
- Metal luer lock tip
- Removable barrel for cleaning
- Durable plastic design
- Amber-colored barrel reduces UV sunlight exposure

ITEM#	Description	Price
031817	2EM-BT Bottle Top Syringe	\$33.19



5VM Automatic Syringe (Allflex)

- Automatic self-filling rear tube feed
- Adjustable dosage from 0.5 mL to 5 mL
- Durable metal construction
- O-ring plunger
- Contoured easy-grip handle for high-volume use
- Amber-colored barrel reduces UV exposure

ITEM#	Description	Price
023627	5VM Draw-Off Injection Syringe	\$84.89



INJECTION ENSURES WHAT
INGESTION ALONE CAN'T.

EVERY ANIMAL. EVERY TIME.



Multimin® 90 (zinc, copper, manganese, and selenium injection) delivers essential trace minerals to cattle. Adding it to your oral nutrition program helps prepare your herd when it matters most.

DON'T CHANCE IT. LEARN MORE AT AXIOTA.COM.

IMPORTANT SAFETY INFORMATION FOR MULTIMIN® 90: Not for use in humans, keep out of reach of children. Multimin 90 has a preslaughter withdrawal time of 14 days after injection. Do not use during the first trimester of pregnancy or in pre-ruminant calves as safety has not been established. Selenium and copper are toxic if administered in excess and may lead to sudden death, depression, weakness, ataxia, salivation, and drooling. Do not use concurrently with other selenium or copper injections or boluses. Maximum volume per injection site is 7 mL. Allow a minimum of 30 days before considering repeat dosing. See prescribing information.



Axiota

AA-0000-00 © 2020 Axiota®
axiota.com

Brief Summary of Full Prescribing Information:

MULTIMIN 90 (zinc, copper, manganese, and selenium injection)

Active Ingredients: Zinc 60 mg/mL (as zinc oxide), Copper 15 mg/mL (as copper carbonate), Manganese 10 mg/mL (as manganese carbonate), Selenium 5 mg/mL (as sodium selenite)

Inert Ingredients: Ethyle acid 399.74 mg/mL, Sodium hydroxide 136.9 mg/mL, Benzyl alcohol 10.4 mg/mL (as preservative)

CAUTION: Federal law restricts this drug to use by or on the order of a licensed veterinarian.

INDICATIONS FOR USE

To provide a supplemental source of zinc, copper, manganese, and selenium in cattle. Not for use in pregnant cows and heifers during their first trimester because reproductive safety testing has not been done in these animals. Do not use in beef calves less than 2 months of age, dairy calves, and veal calves because safety has not been established.

Before using this drug, read package insert for full prescribing information.

DOSE AND ADMINISTRATION

Determine accurate body weights prior to treatment. Administer subcutaneously under the loose skin of the middle of the side of the neck per the following dosages depending on age and bodyweight of the cattle.

Cattle up to 1 year, 1 mL/100 lb bodyweight
Cattle from 1-2 years, 1 mL/150 lb bodyweight
Cattle over 2 years, 1 mL/200 lb bodyweight

To be administered as a single dose. The maximum volume per injection site is 7 mL. Use standard aseptic procedures during administration to reduce the risk of injection site abscesses or lesions. Ensure there are at least 4 inches between injection sites for MULTIMIN 90 (zinc, copper, manganese, and selenium injection) and other injection sites.

MULTIMIN 90 is intended as a single dose product. Allow a minimum of 30 days before considering repeat dosing. Additional zinc, copper, manganese, or selenium products should not be administered at the same time.

Use within 28 days of first puncture of the vial and puncture a maximum of 15 times. If more than 15 punctures are anticipated, the use of multi-dosing equipment is recommended. When using a draw-off spike or needle with bore diameter larger than 16 gauge, discard any product remaining in the vial immediately after use.

CONTRAINDICATIONS

Do not use MULTIMIN 90 concurrently with other injectable selenium and copper products. Do not use MULTIMIN 90 concurrently with selenium or copper boluses.

WARNINGS AND PRECAUTIONS

Withdrawal Periods

Cattle must not be slaughtered for human food consumption within 14 days of the last treatment. No milk discard time is required when used according to labeling.

User Safety Warnings

Not for use in humans. Keep out of reach of children. Do not allow children access to used or empty syringes. Wash hands after use.

This product is highly concentrated in zinc, copper, manganese, and selenium. Due to a potential risk of zinc, copper, manganese, and selenium toxicity, care should be

taken when handling the product to avoid accidental self-injection. Symptoms of exposure to zinc, copper, manganese, and selenium include sores, dizziness, vomiting, diarrhea, tachycardia, epigastric pain, tremors, and intractability.

In case of accidental self-injection or ingestion, SEEK IMMEDIATE MEDICAL ATTENTION and take the vial with you.

To report a suspected adverse drug experience or to obtain a safety data sheet, contact Multimin North America, Inc. at 978-372-2202.

ADVERSE REACTIONS

Accidental overdose of copper or selenium through mistaking or the use of multiple sources, including the use of injectable products in addition to high-dosage levels, can result in adverse events, including death, depression, weakness, ataxia, salivation, and drooling.

Animal Safety Warnings and Precautions

Selenium and copper are toxic if administered in excess. MULTIMIN 90 may cause clinical signs associated with copper toxicity or selenium toxicity, including death, if overdosed or used in conjunction with excessive dietary levels of copper and selenium or other selenium or copper products. Additional zinc, copper, manganese, or selenium products should not be administered at the same time. Do not use concurrently with other injectable selenium and copper products. Do not use concurrently with selenium or copper boluses.

MULTIMIN 90 may cause injection site swelling that appears on the day of injection and resolves by 7 days later. MULTIMIN 90 may cause irritation at the injection site that appears the day of injection and may persist for at least 14 days post-injection. These reactions may result in the loss of edible tissue at slaughter.

Do not use in cases of known hypersensitivity to the active

ingredients or to any of the excipients. Do not use in emaciated cattle with a body condition score of 1 on a 5-point scale in dairy or 1-3 on a 9-point scale in beef.

Do not use during the first trimester of pregnancy because safety has not been evaluated. Do not use in pre-ruminant calves because safety has not been evaluated.

TARGET ANIMAL SAFETY

Target animal safety was evaluated in cattle less than 10 months of age. Four non-pregnant females and four intact males received saline, 1x, 3x, or 5x the labeled dose for 3 consecutive days. The only treatment-associated findings from the 1x dose group included injection site swelling and a minor, clinically insignificant, dose- and time-dependent decrease in cholesterol. The treatment-associated findings from the 3x dose group were injection site swelling, a decrease in feed consumption, and a decrease in cholesterol. In the 5x dose group, treatment-associated findings included injection site swelling, a decrease in feed consumption, a decrease in cholesterol, an increase in creatinine kinase, a decrease in calcium, and signs of acute copper toxicity (2 out of 4 animals) including sudden death, depression, weakness, ataxia, salivation, and drooling. Animals in the 5x dose group also had hepatic-centrolobular necrosis on necropsy and an increase in serum chemistries associated with liver damage.

STORAGE, HANDLING, AND DISPOSAL

Store between 15°C and 30°C (59°F and 86°F).

Manufactured by Multimin North America, Inc., Fort Collins, CO 80521

Approved by FDA under NADA# 141-537
T.O. <https://www.accessdata.fda.gov/drugsatfda/drugs/label/141537.pdf>

MULTIMIN 90 is available in 100 mL and 500 mL vials.

Revision date: May 2024



Needle/Syringe Combinations

3 mL Luer Slip with 0.1 mL Graduations

Kendall Monoject® Veterinary Pack

Clear polypropylene hub with metal stabilizing insert
K-3 needle grind specific to animal use
Rigid autoclavable hard pack

Size Guide

Stocked at DeTye

Gauge	5/8"	3/4"	1"	1-1/4"	1-1/2"
20			Monoject Vet		Monoject Vet

Needles

Polypropylene/Aluminum Hub Needles

Kendall Monoject 251® Veterinary Pack

Clear hub with aluminum insert
K-3 needle grind specific to animal use
Fits luer lock or lock slip syringes
Rigid autoclavable hard pack
Tamper-evident heat stake guarantees sterility

Kendall Monoject 201® Veterinary Pack

K-3 needle grind specific to animal use
Autoclavable in rigid pack

Kendall Monoject 250E®

Clear hub with epoxy insert
Ultra-sharp, tri-beveled needle
Anti-coring stainless steel needle
Fits luer lock syringes
Autoclavable in rigid pack

Transfer Needles

Ideal Instruments

Item#	Description	Gauge	Length
000802	Stainless Steel	16	1"

Magrath

Item#	Description	Gauge	Length
004532	Transfer Needle	14	3"

Jorgensen



Item#	Description	Gauge	Length
023137	Transfer Needle	16	1-1/2"

Size Guide

Stocked at DeTye | Poly & Aluminum Available via Special Order

Gauge	1/2"	5/8"	3/4"	1"	1 1/4"	1 1/2"
16			Monoject 201* Monoject 200	Monoject 201 Monoject 200		Monoject 201 Monoject 200
18		Monoject 201	Monoject 251 Monoject 201	Monoject 250E Monoject 250E*** Monoject 201 Monoject 200		Monoject 251 Monoject 250E Monoject 250E*** Monoject 201 Monoject 200
20	Monoject 251* Monoject 250E*		Monoject 251	Monoject 251 Monoject 250E Monoject 250E***		Monoject 251 Monoject 250E Monoject 250E***
21				Monoject 251 Monoject 250E Monoject 250E***		Monoject 250E Monoject 250E***

Vaccination Gun

PRODUCT	DESCRIPTION	ITEM#	PRICE
	PNEU-DART Model 178 Breech Loading Rifle This air rifle is for the person with limited or occasional use for an immobilizing gun. Its design is simple but effective. <ul style="list-style-type: none"> Model 178B Specifications Stock and Action - Benjamin Sheridan Overall Length - 41", Weight - 5.68 lbs. Dart Barrel - .50 cal. Smooth Bore, Sights - Open Range - 5 to 40 yards with 1cc Type 'P' Disposable darts controlled by number of pumps and power control on rear of bolt. Min. 1 pump, Max. 10 pumps. 		CALL FOR BEST PRICE
	PNEU-DART Darts 3/4" Type U 5 ml, 7 ml, 10 ml (If only they could build them faster.)		CALL FOR BEST PRICE

Syringes

Stocked at DeTye Available via Special Order

Capacity	Graduations	Regular Luer (Slip Tip)	Price
1 mL Tuberculin	0.01 mL	Kendall Monoject®	CALL FOR BEST PRICE
	0.01 mL	BD	
	0.01 mL	Exel	
3 mL	0.01 mL	Kendall Monoject®	
	0.01 mL	BD	
	0.01 mL	Terumo Sur-Vet®	
	0.01 mL	Exel	
5 mL	0.2 mL	BD	
	0.2 mL	Terumo Sur-Vet®	
	0.2 mL	Exel	
6 mL	0.2 mL	Kendall Monoject®	
10 mL	0.2 mL	BD	
	0.2 mL	Terumo Sur-Vet®	
12 mL	0.2 mL	Kendall Monoject®	
20 mL	1 mL	Kendall Monoject®	
	1 mL	BD	
	2 mL	Terumo Sur-Vet®	
30 mL	1 mL	BD	
	2 mL	Terumo Sur-Vet®	
35 mL	1 mL & 1/4 oz	Kendall Monoject®	
60 mL	5 mL & 1/4 oz	Kendall Monoject®	
	5 mL	BD	
140 mL	5 mL & 1/4 oz	Kendall Monoject® *	

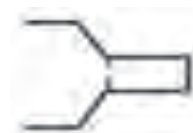

Slip Tip Syringe



Luer Lock Syringe

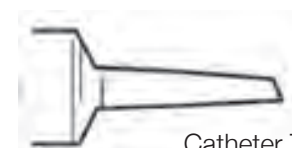

Catheter Tip Syringe

Measuring Tapes

	PRODUCT	DESCRIPTION	ITEM#	PRICE	MFR.
	Calfscale Birthweight Tape	Accurately measures birthweights of newborn beef calves within 24 hours after birth. Place the tape around the coronary band of the front hoof, tighten, and read the circumference in centimeters and the birthweight in pounds from the tape scale. One side measures bulls, the other measures heifers.	023257	\$12.99	Nasco

DISCLAIMER

Because of ever-changing market prices & manufacturers programs, prices are subject to change without notice. You will be notified of all possible savings programs & price breaks to the best of our ability. We encourage you to call to discuss a program that would best fit your needs.

Because of the possibility of typographical or human error, DeTye disclaims responsibility for errors. DeTye also disclaims any responsibility for the use or misuse of products & the methods of use described in this catalog. The manufacturers label should always be followed. Purchasers & users should always follow their veterinarians recommendations.

Extended-Release Injectable Paste/Cake

1% Sterile Solution

For the Treatment and Control of Internal and External Parasites of Cattle (Pasture with Persistent Effectiveness).
Not for use in female dairy cattle 20 months of age or older, including dry dairy cows. Not for use in calves to be processed for veal.

Not for use in breeding bulls, or in calves less than 3 months of age.

Not for use in cattle managed in feedlots or under intensive rotational grazing.

CAUTION: Federal law restricts this drug to use by or on the order of a licensed veterinarian.

INDICATIONS FOR USE

LONGRANGE, when administered at the recommended dosage of 1 ml per 110 lb (50 kg) body weight is effective in the treatment and control of the following internal and external parasites of cattle:

Gastrointestinal Roundworms	Langeworms
<i>Abomasium phalaris</i> – Adults and L ₁	<i>Dicrocoelium viviparum</i> – Adults
<i>Cyathostomum</i> – Adults and L ₁	
<i>Cooperia punctata</i> – Adults and L ₁	Gnats
<i>Cooperia omeiensis</i> – Adults and L ₁	
<i>Haemonchus placei</i> – Adults	Agrocybae
<i>Oxyuris equi</i> – Adults	
<i>Strongylus edentatus</i> – Adults	Mites
<i>Ostertagia circumcincta</i> – Adults, L ₁ , and inhibited L ₁	
<i>Tachystrongylus axei</i> – Adults and L ₁	Scrophularia var. Axi
<i>Tachystrongylus axei</i> – Adults	

Parasites	Duration of Persistent Effectiveness
Gastrointestinal Roundworms	
<i>Abomasium phalaris</i>	150 days
<i>Cooperia punctata</i>	100 days
<i>Cooperia omeiensis</i>	100 days
<i>Haemonchus placei</i>	120 days
<i>Oxyuris equi</i>	120 days
<i>Ostertagia circumcincta</i>	120 days
<i>Ostertagia circumcincta</i>	120 days
<i>Tachystrongylus axei</i>	100 days
Langeworms	
<i>Dicrocoelium viviparum</i>	150 days

DOSE AND ADMINISTRATION

LONGRANGE® (eprinomectin) should be given only by subcutaneous injection in front of the shoulder at the recommended dosage level of 1 mg eprinomectin per kg body weight (1 ml per 110 lb body weight). Each ml of LONGRANGE contains 50 mg eprinomectin, sufficient to treat 110 lb (50 kg) body weight. Divide doses greater than 30 ml between two injection sites to reduce occasional discomfort or site reaction.

Do not overdress. Insure each animal receives a complete dose based on a current body weight. Underdosing may result in ineffective treatment, and encourage the development of parasite resistance.

LONGRANGE is to be given subcutaneously only. Animals should be appropriately restrained to achieve the proper site of administration. Inject under the loose skin in front of the shoulder (see illustration) using a 16 or 18 gauge, 1/2 to 1 1/2 inch needle.

Sanitize the injection site by applying a suitable disinfectant. Clean, properly distributed needles should be used to reduce the potential for injection site infections.

Body Weight (lb)	Use Volume (ml)
110	1
220	2
330	3
440	4
550	5
660	6
770	7
880	8
990	9
1100	10

**Withdrawal Periods and Label Warnings**

Animals intended for human consumption must not be slaughtered within 42 days of the last treatment. This drug product is not approved for use in female dairy cattle 20 months of age or older, including dry dairy cows. Use in these cattle may cause drug residues in milk and/or in calves born to these cows. A withdrawal period has not been established for pre-maturing calves. Do not use in calves to be processed for veal.

Animal Safety Warnings and Precautions

The product is likely to cause tissue damage at the site of injection, including possible granuloma and necrosis. These reactions have developed without treatment. Local tissue reaction may result in tissue loss at injection site.

Observe cattle for injection site reactions. If injection site reactions are expected, consult your veterinarian. This product is not for intravenous or intramuscular use. Protect product from light. LONGRANGE® (eprinomectin) has been developed specifically for use in cattle only. This product should not be used in other animal species.

When to Treat Cattle with Gnats

LONGRANGE effectively controls all stages of cattle gnats. However, proper timing of treatment is important. For the most effective results, cattle should be treated as soon as possible after the end of the feed fly (gnat) fly season.

Environmental Hazards

Not for use in cattle managed in feedlots or under intensive rotational grazing because the environmental impact has not been evaluated for these scenarios.

Other Warnings: Parasite resistance may develop to any dewormer, and has been reported for most classes of dewormers.

Treatment with a dewormer used in conjunction with parasite management practices appropriate to the geographic area and the animal(s) to be treated may slow the development of parasite resistance.

Local examinations or other diagnostic tests and parasite management history should be used to determine if the product is appropriate for the herd/flock, prior to the use of any dewormer. Following the use of any dewormer, effectiveness of treatment should be monitored (for example, with the use of a fecal egg count reduction test or another appropriate method).

A decrease in drug effectiveness over time as calculated by fecal egg count reduction tests may indicate the development of resistance to the dewormer administered. Your parasite management plan should be adjusted accordingly based on regular monitoring.

Microscopic lactones provide prolonged drug exposure that may increase selection pressure for resistant parasites. This effect may be more pronounced in extended-release formulations.

TARGET ANIMAL SAFETY

Clinical studies have demonstrated the wide margin of safety of LONGRANGE® (eprinomectin). Dosing at 1 to 5 times the recommended dose resulted in a statistically significant reduction in average weight gain when compared to the group treated at label dose. Treatment-related lesions observed in most cattle administered the product included swelling, hyperemia, or necrosis in the subcutaneous tissue of the skin. The administration of LONGRANGE at 1 times the recommended Paste/Cake dose had no adverse reproductive effects on beef cows at all stages of breeding or pregnancy or in their calves.

Not for use in bulls, as reproductive safety testing has not been conducted in males intended for breeding or actively breeding, but for use in calves less than 3 months of age because safety testing has not been conducted in calves less than 3 months of age.

STORAGE

Store at 27° F (2° C) with excursions between 15° and 86° F (5° and 30° C). Protect from light.

Approved by FDA under NADA 141-127

Made in Canada.

Manufactured by Boehringer Ingelheim Animal Health USA Inc., Kenilworth, NJ 07033

The Cattle Head Logo™ (TM) and RUMOR are trademarks of

Boehringer Ingelheim Animal Health USA Inc.

© 2012 Boehringer Ingelheim Animal Health USA Inc. All rights reserved.

100-289-08, Rev. 11/2011, B010163 05-004-0011-2011

TO ANYONE WHO SAYS SUCCESS TAKES COMPROMISE.

HERE'S PROOF
THEY'RE WRONG.



If you're committed to being the very best, there's only one choice for your dewormer: LongRange® (eprinomectin). It's the only dewormer that provides up to 150 days of parasite control.¹ It's what helps top producers get bigger gains, better reproduction and greater returns. It's the difference between being average and being at the top of your game. So, next time you're deworming cattle, don't just get the job done. **Get it outdone.**

PROVEN TO PAY OFF IN
POUNDS AND DOLLARS.
CALCULATE THE RETURN
FOR YOUR HERD.









thelongrangelook.com/longrange-calculator

OUTLAST. OUTPERFORM. OUTDO.

LONGRANGE IMPORTANT SAFETY INFORMATION: Do not treat within 48 days of slaughter. Not for use in female dairy cattle 20 months of age or older, including dry dairy cows, or in veal calves. Post-injection site damage (e.g., granulomas, necrosis) can occur. These reactions have disappeared without treatment. Not for use in breeding bulls, or in calves less than 3 months of age. Not for use in cattle managed in feedlots or under intensive rotational grazing.

¹ Dependent upon parasite species, as referenced in EPR summary and LONGRANGE product labels.

Scrubs & Antiseptic Hand Soaps

PRODUCT	DESCRIPTION	ITEM#	SIZE	PRICE	MFR.
	An antiseptic, microbicidal, sudsing skin cleanser for pre-operative scrubbing and washing by surgeons and pre-operative preparation of patients' skin. Contains 10% povidone iodine. 100% effective and non-irritating.	004513	16 oz	\$21.39	Purdue Fredrick Co.
		003234	Gallon	\$74.39	
	A topical, water-based antiseptic microbicide used to kill bacteria, fungi and viruses. Contains povidone-iodine. Use full strength for: <ul style="list-style-type: none"> • Preoperative prepping of skin and mucous membranes. • Preventing bacterial infection. • Emergency antiseptis of minor lacerations, abrasions, and burns. • Postoperative application to surgical incisions. 	004677	16 oz	\$18.79	Purdue Fredrick Co.
		003233	Gallon	\$66.79	
	Chlorhexidine Scrub 2%	003605	Gallon	\$53.97	Vet One
	Chlorhexidine Solution 2%	501027	Gallon	\$21.50	Vet One
	An EPA-registered chlorhexidine disinfectant that works against at least 60 different bacteria, fungi, yeasts, and viruses. It is non-corrosive, has minimal to no skin irritation, and retains antimicrobial activity in the presence of organic matter. The unique binding of Nolvasan to skin proteins provides residual activity for as long as 2 days. Unscented formula. Contains chlorhexidine diacetate.	007860	Gallon	\$205.79	Zoetis
	Vetericyn Wound & Skin Care heals wounds fast. It cleans, treats and heals wounds and infections without harming healthy tissue. Vetericyn effectively kills antibiotic-resistant strains of bacteria, fungi, viruses and spores. Use Vetericyn to treat conditions like rain rot, cuts, burns, rashes, eye or ear infections, ringworm, strangles, skin infections and skin fungus.	037621	8 oz	\$20.89	Vetericyn
		037620	16 oz	\$26.98	
	Vetericyn Pink Eye Spray is formulated especially for eyes that are irritated by the effects of pinkeye. Stronger than other Vetericyn formulas for the prevention and control of outbreak conditions. Apply directly to the eyes to provide relief from infection, burning, stinging, itching, pollutants and foreign materials.	037118	16 oz	\$30.49	Vetericyn
	Vetericyn® Super 7+™ Navel Dip dries down the umbilical cord 50% faster than 7% iodine tincture. Solution is dyed brown solution to allow for rapid identification after treatment. Completely safe for animals and the environment. Non-flammable. Non-toxic. Developed strictly for the purpose of animal umbilical cord dry-out as an effective alternative to strong iodine. For use on cattle, horses, swine, sheep, goats and dogs. Do not freeze. Made in USA.	090161	16 oz	\$12.19	Vetericyn



Cross 5 Cattle Coolers

PRODUCT	DESCRIPTION	PRICE
3 Holster Coolers	Ranch Hand Cooler includes cooler, 2 interior dividers and utility tray, plain	\$409.99
4 Holster Coolers	Ranch Hand Cooler includes cooler, 3 interior dividers and utility tray. plain	\$424.99
Interchangeable Side Lid	Accessory	\$49.99
Holster Plugs	Accessory	\$4.00



Clippers

PRODUCT			ITEM#	SIZE	PRICE
	Oster Clipper A5 Turbo	1 speed with #10 clip on blade	021602		\$171.09
		2 speed with #10 clip on blade	021606		\$206.19
	Oster ClipMaster	Single speed	003027		\$359.49
	3" Head	Variable speed	001978		\$377.99
	Oster Clipper Power Pro Cordless Pro Kit	With blade	119227		\$339.39
	Oster Shearmaster	Single speed, 3" head	014975		\$411.89

Hot Shots





PRODUCT			ITEM#	SIZE	PRICE
	Springer Magrath Co Hot Shot Power Pack	14 Month Warranty 1.5 Volt	003072		\$87.39
	Springer Magrath Co Stock Prod Shaft		004196	44"	\$28.79
			004197	34"	\$26.09
			003071	22"	\$24.19
			004045	9"	\$23.79
	Dura Prod Hot Shot Rechargeable Handle	Rechargeable with 32" prod	029848		\$227.89
	Dura Prod Hot Shot Battery Kit		004292		\$161.99
	Dura Prod Handle	1.5 Volt	029918		\$159.00
	Sharpshock Standard Handle	Separate on/off switch and power button Completely sealed and waterproof motor Separate on/off switch and power button 1.5 Volt	054274		\$62.99
	Sharpshock Rechargeable Handle	Separate on/off switch and power button Completely sealed and waterproof motor Separate on/off switch and power button	098946		\$94.09
	Sharpshock Flexible Shaft	Shaft Tip - Double insulated and flexible Flexible and Durable shaft - Maintain flexibility and durability in extreme temperatures and all weather conditions Extended locking nut - Alleviates pressure from threading to make a stronger, secure fit	054271	23"	CALL FOR BEST PRICE
			054273	33"	
			054272	43"	







Orphan-No-More

PRODUCT			ITEM#	SIZE	PRICE
	Orphan-No-More™ (formerly O-No-More™)	Aids newborn calf adoption by natural or foster mothers. The easy-to-use powder has been field tested on cattle in Nebraska and Iowa. Directions: Sprinkle a liberal amount down backline from ears to tail head of calf to be adopted. If calf is dry, dampen the area before use for better adhesion. Whenever feasible, confine mother (or foster mother) and calf in close quarters, preferably out of the wind, since odor plays an important role in calf adoption.	000899	9 oz	\$21.29

Callicrate Bander

PRODUCT			ITEM#	SIZE	PRICE
	Callicrate Bander Kit		017427		\$419.79
	Callicrate Bands		012618	25 ct.	\$85.09
			012619	100 ct.	\$338.69
	Wee Bander		040128		Special Order
	Ideal Economy Elastrator Bander	Calves, lambs, & goats	007960		\$14.99
	Ideal Premium 12"		036604		\$30.99
	Ideal Elastrator Bands			100 ct.	\$4.99

OB

PRODUCT			ITEM#	SIZE	PRICE
	OB Chain	Ideal 30"	000875		\$9.89
		Ideal 45"	008682		\$12.19
		Ideal 60"	005664		\$14.09
		Stone 60" nickle plated steel	035788		\$56.69
	OB Chain Hook	nickle plated steel	012636		\$22.99
	OB Strap	with chain, calf 52"	029772		\$14.99
		nylon, 30"	004459		\$8.99
		nylon, 60"	004458		\$11.99
	OB Wire	Stone, 32"	014118		\$40.29
	OB Wire Handle Saw	Stone	000925		\$24.29

Whether in the dry lot or on pasture, there's an implant for that.

Having the flexibility to dial in or to step up the trenbolone acetate (TBA) and estradiol benzoate dosage is important to managing cattle weight gain goals. Zoetis has been a leader in offering a variety of formulations through continued research and development of implants that can fit every beef production phase. The Synovex[®] implant portfolio can help you achieve your goals with Synovex Primer[™] and Synovex Choice[™] in the dry lot or on pasture.

Prime them for weight gain.



Start your cattle with purpose.

A low-dosage implant with 50 mg of TBA and 7 mg of estradiol benzoate can help them gain weight and grow efficiently, and is approved for use on pasture or in dry lot settings.

- ✓ On pasture, cattle receiving Synovex Primer posted a gain of 1.43 lb./head/day compared with 1.29 lb./head/day for sham implanted cattle ($p=0.0014$).¹
- ✓ Synovex Primer significantly increased average daily gain (ADG) compared with the sham implanted group, 2.47 vs. 2.21 lb./head/day ($p = 0.0016$) over the course of a 90-day study.¹

Prime them for precision.

Optimize your cattle management by dialing in the starting TBA and estradiol dosage to match cattle type, nutrition and performance goals.

Gain more with Synovex Choice[™].



Sometimes you need a higher dose of TBA.

Synovex Choice is a moderate TBA implant, with 100 mg of TBA and 14 mg of estradiol benzoate, approved on pasture and in dry lot settings.

- ✓ On pasture, cattle implanted with Synovex Choice gained 1.49 lb./head/day, while sham-implanted cattle gained 1.29 lb./head/day ($p=0.0007$).¹
- ✓ Dry lot research demonstrated a gain of 2.50 lb./head/day vs. 2.21 lb./head/day ($p = 0.0016$) over the course of the 90-day study.¹

Grow your operation, without the fat.

Achieve your operation's growth goals by more consistently developing cattle with more lean muscle and less fat.

Synovex brings flexibility to cattle management

When you are evaluating options for implants in the dry lot or for pasture cattle, there are key considerations when selecting the implant for your program:

- ✓ Nutritional status
- ✓ Production goals
- ✓ Type of cattle
- ✓ Duration on grass

Get more information, including details about industry-leading service, chuteside training and technical support from Zoetis, at [Synovex.com](https://www.synovex.com).

Refer to individual labels for complete directions for use, precautions, and warnings. Reimplant only if and as directed in labeling. Synovex Primer contains 50 mg trenbolone acetate and 7 mg estradiol benzoate. Synovex Choice contains 100 mg of trenbolone acetate and 14 mg estradiol benzoate.

¹Synovex Choice and Synovex Primer Freedom of Information (FOI) Summary, NADA 141-045
All trademarks are the property of Zoetis Services LLC or a related company or a licensor unless otherwise noted.
© 2024 Zoetis Services LLC. All rights reserved. SYN-0042381

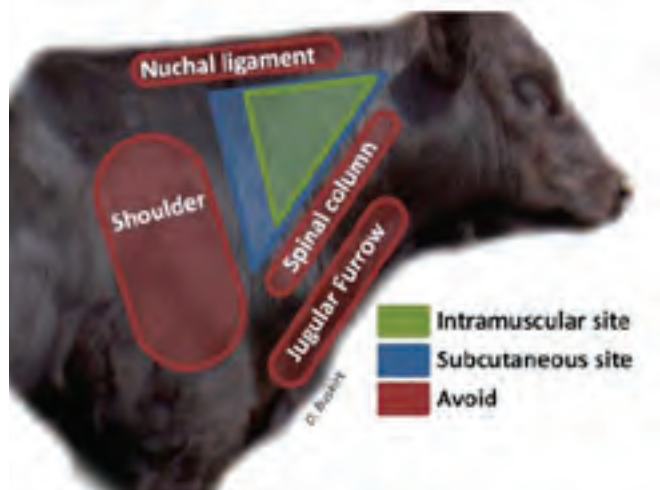

INJECTION TECHNIQUE

There is a negative relationship between meat tenderness and injection sites, including injection sites that have no visible lesion. In fact, intramuscular (IM) injections, regardless of the product injected, may create permanent damage regardless of the age of the animal at the time of injection. Tenderness is reduced in a three-inch area surrounding the injection site.

Moving the injection-site area to the neck stops damage to expensive steak cuts. Therefore, cow-calf producers should make certain that family members and hired labor are sufficiently trained as to the proper location of the injections before the spring calf-working begins.

Give injections according to label instructions. Subcutaneous (SQ) means under the skin, intramuscular (IM) means in the muscle. Some vaccines (according to the label instructions) allow the choice between intramuscular (IM) and subcutaneous (SQ).

Always use subcutaneous (SQ) as the method of administration when permitted by the product's label. Remember to "tent" the skin for SQ injections unless instructed otherwise by the manufacturer. Proper injection technique is just one of many components of the Beef Quality Assurance effort that has had a positive impact on the entire United States beef industry.

By Glenn Selk, www.beefmagazine.com





Calf Pullers

PRODUCT		ITEM#	SIZE	PRICE
	<p>"Dr. Franks" Ideal Fetal Extractor</p> <p>Includes 23" breech</p> <p>Operated with rotating motion at a speed consistent with dialation of pelvic muscles</p>	004786		\$376.59
	<p>"Calf Eze" Ideal Fetal Extractor</p> <p>23" breech</p> <p>Suggested to use with 2- 45" OB chains</p> <p>Dual action, or zig-zag, instead of single-pull instrument</p>	012744		\$412.00
	<p>"Ratch-a-Pull" Stone Fetal Extractor</p> <p>With breech spanner & strap</p> <p>77"</p>	012856		\$391.69
	<p>Hercules Fetal Extractor</p> <p>Calf puller</p> <p>Jorgenson</p>	000260		\$246.19



What makes them different makes them better.

Only TRI-ZAP® tags combine three powerful ingredients for fast, long-lasting control of profit-robbing flies.

It's a fact: TRI-ZAP® insecticide ear tags from Y-TEX® are the only tags on the market with three proven active ingredients to stop horn flies, face flies, lice and ear ticks dead in their tracks. Even those resistant to other tags. Two tags per head control horn flies up to four months and spinose ear ticks up the three months. So ask your livestock products supplier for the triple-action power of TRI-ZAP® insecticide cattle ear tags, or visit us at www.ytex.com to learn more.

Rotate for Best Results



Electronic ID (EID) Tags



ComfortEar™ EID Tags (Datamars)

The unique convex back of the ComfortEar tag provides greater comfort for the animal as well as faster wound healing. Over-molded technology protects the electronic components from the elements. Tags have a plastic locking device for easier application, better retention and improved read range. Temple EID tags have superior readability compared to all other tags on the market as tested by two independent labs.

- FDY-B Technology (134.2 kHz)
- ISO 11784/11785 compliant
- Provides lifetime tracking
- Preprogrammed with international ISO number
- Available in standard open or tamper evident
- Lightweight (7.2 grams)
- Applied with standard Temple rivet using the Temple Herdsman II applicator



High-Performance Half Duplex (HDX) EID Tag (Allflex)

- Tamperproof design that provides the ultimate in usability, security and retention (tamperproof cattle tags can be identified by the Ultra Tamperproof cap)
- HDX technology optimizes signal transmission and provides the greatest possible read distance
- Useful in packing plants, with automated reading systems, or with a walk-through reader
- Extended Small Males (included with tags) are used for placement in a deeper location in the ear.
- Apply with Allflex Universal Total Tagger (Red) or Allflex Ultra Retract-O-Matic for EID tags

ITEM#	Description	Unit	Color
027130	High-Performance Half Duplex (HDX) EID Tag	Pack of 50	White
027129	High-Performance Half Duplex (HDX) EID Tag	Pack of 250	White
029813	High-Performance Half Duplex (HDX) EID Tag	Pack of 1000	White



High-Performance (HDX) Reusable EID Tag (Allflex)

- Can be reused to lower the per-animal cost of EID
- Extended Small Males (included with tags) are used for placement in a deeper location in the ear
- Apply with Allflex Universal Total Tagger (Red) or Allflex Ultra Retract-O-Matic for EID tags

ITEM#	Description	Unit	Color
027132	High-Performance Reusable EID Tag	Pack of 50	Yellow
027131	High-Performance Reusable EID Tag	Pack of 250	Yellow



Standard Performance Full-Duplex (FDX) EID Tag (Allflex)

- Tamperproof design that provides the ultimate in usability, security and retention (tamperproof cattle tags can be identified by the Ultra Tamperproof cap)
- FDX technology is sufficient for capturing data
- Extended Small Males (included with tags) are used for placement in a deeper location in the ear.
- Apply with Allflex Universal Total Tagger (Red) or Allflex Ultra Retract-O-Matic for EID tags

ITEM#	Description	Unit	Color
027127	Standard Performance Full-Duplex (FDX) EID Tag	Pack of 50	Yellow
027126	Standard Performance Full-Duplex (FDX) EID Tag	Pack of 250	Yellow
029814	Standard Performance Full-Duplex (FDX) EID Tag	Pack of 1000	Yellow



EID Large or Maxi Visual Matched Sets (Allflex)

These sets are a combination of an HDX High Performance Ultra EID tag and a matching Large Visual tag with corresponding laser/ink printed numbering. The full EID number is printed in the neck area of the visual tag. All tags feature a tamperproof design. Tag numbers contained in the package can be downloaded to the Allflex EID Tag Number Look Up site (www.allflexlink.com), and this information can be easily migrated or merged to an existing database or management program without any reading equipment. Sets are available in 3 customizable combinations, which include basic tags with a management number, to combinations with logos and reverse-side marked text. Available in 7 colors. Full-duplex (FDX) and 840 or 982 coded tags are also available.



Allflex RS420 Stick Reader

- Portable reader with cord-free capabilities
- High Contrast LCD
- Cable free Operation
- Internal Bluetooth
- Rechargeable 7.4 VDC Li-Ion Battery
- 100,000 ID Tag Storage (10,000 per session)
- Comes Standard with EID Tag Manager Software RS420 Stick Reader
- 60cm – SKU: RS420-60
- 45cm – SKU: RS420-45

RS420 Stick Reader “Pro Kit”

- Rugged hard-sided plastic case
- PW420 Replacement Battery Pack 7.4VDC
- EID Tag Manager Software
- Pro Kit available for both sizes: RS420-60-KIT & RS420-45-KIT

One-Piece Ear Tags

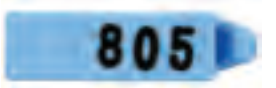

Original Temple Tags (Temple Tag)

- The first plastic identification system ever produced
- Molded from a permanently colored, weather-resistant polymer—will not crack, break, freeze, or fade
- Snag-proof, open-end construction allows the tag to free itself from fences or brush without damage to the tag or ear
- One-step application
- Quick, easy, and permanent
- An excellent hospital tag because of outstanding retention
- Available in 2 sizes for cattle, sheep, goats, hogs, and wildlife
- Available blank or imprinted with up to 5 numbers on the large size and 4 numbers on the small size
- Personalize with up to 2 lines of 8 letters each on small size and up to 2 lines of 10 letters each on the large size

Y-Tag®



Y Tag® Cow & Calf Tags

Y-Tags feature the exclusive Surgi-Tip tag tip, a unique four-sided tip design for a precise incision, faster healing and improved retention. Calf tags have a printable area of 2 1/8" x 1 1/2" and can be custom printed with any text, logos, or numbers using 100% PureLaser permanent imprinting. Y-Tags can be applied with the Y-Tags applicator or many other popular one-piece tag applicators.

Z Tag®



Z Tag® Cow & Calf Tags (Z Tags® North America)

Revolutionary one-piece tagging system with proven superior retention. Users report remarkable retention rates under the most challenging conditions. Soft, flexible material bends and releases when tag gets hooked on brush, wire or twine, while the tag stays in the ear. Self-cutting tip makes a small incision that heals tightly around tag. Available blank, numbered or custom hot-stamped in either cow or calf size with 9 colors (black (special order), blue, chartreuse, green, orange, pink, purple, red, turquoise, white, and yellow).

Z Tag® No-Snag Sheep & Goat Tags (Z Tags® North America)

Ideal for piglets, sheep, goats and small calves. Superior retention. The self-contained cutting tip makes a small incision that heals quickly and tightly. Excellent for tagging young livestock with soft ears. Flexible tag bends easily, reducing hang-ups and lost tags. Available blank or long-lasting laser printing in 8 colors (blue, green, orange, pink, purple, red, white, and yellow).



Z Tag® Feedlot Tags (Z Tags® North America)

Designed to meet the needs of feedlot identification programs.

- Superior readability from front or back
- Fool-proof one-piece design means the back of the tag will not snag and pull out or break off
- Unique pivoting applicator pin makes loading easy and eliminates ripped ears
- Exclusive self-piercing tip makes a clean, precise incision to help prevent infection and disease transfer
- Available in black (special order), yellow, green, gray, orange, peach, white, pink, purple, red, rose, chartreuse, and blue.



Z Tag® Z2 Two-Piece Tags (Z Tags® North America)

- Easier to read from front or back
- Exclusive laser printing is guaranteed for the life of the animal
- Meets or exceeds specifications for Breed Associations and Beef Alliance ID Programs
- Tag rotates freely to ensure that it hangs correctly
- Exclusive self-piercing tip makes a clean, precise incision that helps prevent infection and disease transfer
- Unique pivoting applicator pin makes loading easy and eliminates ripped ears
- Available in tamperproof or reusable styles
- Multiple tag combinations available in 14 colors

Feeder Ear Tags



Advantage Feeder Tags (Allflex)

Advantage feedlot tags, available in two sizes (Advantage and Advantage Maxi), incorporate product features that are preferred by many segments of the stocker/feeder industry.

- Unique shape with more panel space for marking
- Engineered neck and shoulder to reduce twisting
- Advanced pliable plastic for longevity and easy stamping
- Fast application with Allflex Easy Applicator knife
- 20 colors available
- Custom marking and onsite hot stamp marking capabilities

Feedlot Tags (Allflex)

Allflex Feedlot Tags have high retention rates and easy readability. In tests on thousands of cattle over full 120-day feeding periods, the tags had less than one-half percent loss. The tags hang straight in the ear. Allflex Feedlot Tags are stocked in standard packages of 50 blank tags. Lot numbering, sequential numbering and custom marking are available by special order. Tag measures 4-1/4"H x 3"W. Available in 20 colors.



Feeder Ear Tags (Temple Tag)

- Outstanding retention
- Wide, long head to greatly resist falling out
- Sloped shoulder resists drag
- Excellent visibility
- Weather resistant
- Easy to apply
- Imprinted or numbered front and back
- Thick neck does not break
- Soft, durable plastic resists weather damage and improves hot stamping
- Available in 15 colors and two sizes: Feeder and Super Feeder

Feedlot Tags (Y-TEX)

These practical, no-nonsense feedlot ear tags are ideal for high-volume, short-term applications. They are manufactured using specifically engineered polyurethane material that provides excellent mechanical properties as well as flexibility under all outdoor environments. Tags offer excellent ear tag retention by using the locking tab design. They also provide the greatest visibility by incorporating the longest ear tag neck design in the feedlot tag industry.

Two-Piece Ear Tags



Global Female Ear Tags (Allflex)

The Allflex Global Tag System encompasses the latest innovations in livestock visual identification. This tag offers producers a practical, cost-effective management tool.

- For use in beef and dairy cattle & designed with improved retention collar
- Patented laser-ink marking with matching laser-etched number into tag surface guarantees permanent identification for the life of the animal
- Self-piercing Global Small Male button (included) makes application easy and reduces risk of infection
- Available in 9 colors, blank or numbered
- Two sizes: Large (3" H x 2-1/4" W) and Maxi (4" H x 3" W)

Global Small Male Ear Tags, Blank (Allflex)

- Key to the performance of Allflex Global Tagging System
- For use in all livestock species
- Self-piercing closed tip & engineered for superior retention
- Available in 9 colors, blank or numbered
- Companions to Global Medium Female, Large Female, Maxi Female and Super Maxi Female tags

All American® Two-Piece Ear Tag System (Y-TEX)

All-American tags use an advanced polyurethane formulation for a softer, more flexible tag. Special ultraviolet light inhibitors stop fading for superior hot stamped or inked imprint life. The long, ribbed neck prevents breakage and allows greater tag visibility. Sloped tag shoulders combined with Y-TEX's flexible button and patented Snap-Lok™ collar provide superior resistance to snagging and prevents tag-button separation.

- 3-Star Tags for cows and calves measure 3-7/8" H x 2-1/2" W
- 4-Star Tags for cows measure 4-3/4" H x 3-1/4" W
- 2-Star Tags for cows and calves measure 3-1/4" H x 2" W
- 1-Star Tags for sheep and goats measure 2" H x 1-5/8" W





**Made with pride in the USA.
Always have been. Always will be.**

Y-TEX® ID ear tags give you American quality at its very best.

At Y-TEX®, we don't believe in off-shoring production of our All-American® two-piece tags or Y-Tags™ one-piece visual identification ear tags. After all, why risk shipping bottlenecks and other supply chain problems just to save a few pennies per tag in production costs?

Every American-made Y-TEX® ID tag features advanced polyurethane construction for unmatched flexibility and durability. State-of-the-art 100% PureLaser™ imprinting for superior legibility that's guaranteed for the life of the animal. Minimally invasive tips for faster healing and maximum tag retention. And, easy-to-use taggers for time-saving convenience.

If you take pride in a job well done and believe in American quality, ask your livestock products supplier for Y-TEX® ID ear tags or go to www.y-tex.com to learn more.

Always read and follow label directions. Y-TEX® and All-American® are registered trademarks of Y-TEX Corporation. Y-Tags™ and PureLaser™ are trademarks of Y-TEX Corporation. © 2022 Y-TEX Corporation.



Y-TEX®
EXCELLENCE IN ANIMAL HEALTH™

Applicators



Allflex Applicator
\$38.49



Y-TEX Ultra Tagger
\$35.59

Z-Tag® Applicator
Z1 No-Swag \$37.99



Marking Pens



2-in-1 Marking Pen (Allflex)

One pen with two marking tips (fine and broad), easy to hold, easy-to-use pump action, fade-resistant ink

ITEM#	Description	Color	Price
010609	Allflex 2-in-1 Marking Pen	Black	\$8.99
022840	Allflex 2-in-1 Marking Pen	White	\$8.99

Ball Tip Markers (Y-TEX)

Print anything that you want on your tags with these ball-tip markers. White or black ink for every color of tag.

ITEM#	Description	Size	Color	Price
041034	Tag Ink with interchangeable tip	1 oz	Black	\$10.09



Z® No-Fade Ink Marker (Z Tags® North America)

Designed exclusively for use with New Z tags, the special deep penetrating ink actually penetrates halfway through the porous urethane plastic.

ITEM#	Description	Price
013805	New Z No-Fade Ink Marker	\$11.89

Supermark Pen (Destron Fearing)

Features a new deep-penetrating formula. Improved valve system allows ink to flow easily. Comes with two broad tips and one fine tip. Five-year guarantee on number life.

ITEM#	Description	Price
001254	Supermark Pen	\$8.59

Ear Tag Removers





Ear Tag Removal Knives

ITEM#	Description	Mfr.	Price
019649	Ear Tag Removal Knife	Destron Fearing	\$6.29
002858	Ear Tag Removal Knife	Allflex	\$6.29

Marking Paint

PRODUCT	DESCRIPTION	SIZE	UNIT	COLOR	PRICE	MFR.
	<ul style="list-style-type: none"> New high-visibility fluorescent colors available Unit Packaging: Packed in one dozen display box Assorted box contains 3 each of red, blue, green and orange Size: 1" x 4" 	1" x 4"	Pack of 12	Fluorescent Green, Orange, Pink, Tangerine, Yellow	\$14.39	Lake Chemical
				Green, Light Blue, Orange, Purple, Red, Silver, Yellow, Black, Blue	\$13.99	
		Each	Black	\$13.89		
	<ul style="list-style-type: none"> Twist-up holder helps keep hands and clothing clean Unit Packaging: Packed in one dozen display box Size: 1-1/4" x 4-3/4" 	1-1/4" x 4-1/4"	Pack of 12	Fluorescent Pink	\$39.00	Lake Chemical
				Blue	\$34.59	
				Green		
				Orange		
				Red		

Electrolytes

	PRODUCT	DESCRIPTION	ITEM#	SIZE	SPECIES	FORM	PRICE	MFR.
	Entrolyte HE	Provides a source of electrolytes that are typically lost in cases of scours. High-energy formulation with a high glucose content. For oral use in calves only.		178 gram	Calf	Powder	\$6.09	
	Resorb	Oral hydration electrolyte product for scouring calves. Easy to mix, palatable formula, tastes good.		12 count	Calf	Powder	\$44.64	
				72 count	Calf	Powder	\$232.67	
	Hydra Lyte			5.7 oz		Powder	\$6.10	
				18 lb.		Powder	\$174.79	
	Replenish Blue Lite	A nutritional supplement for calves providing oral hydration support.		4 oz.	Calf		\$5.49	
				1 gallon	Calf		\$77.99	









Meal Replacers & Supplements: Cattle

	PRODUCT	DESCRIPTION	ITEM#	SIZE	SPECIES	FORM	PRICE	MFR.
	IgG Colostrx [®] CR Colostrum Replacer	Contains 100 grams of globulin protein, the most of any replacer on the market. Designed to completely replace maternal colostrum for newborn dairy or beef calves. It is an excellent alternative to maternal colostrum, delivering a consistent, high-quality dose of globulin protein and other important nutrients. For best results, administer with a nipple pail, bottle, or esophageal feeder within 24 hours after birth (immediately if practical), then follow normal feeding program.	034642	700 gram	Calf	Powder	\$51.69	Alta Genetics
	IgG Colostrx [®] CS Colostrum Supplement	Provides 50 grams of globulin protein and other essential nutrients to supplement maternal colostrum in newborn calves. For best results, administer with a nipple pail, bottle, or esophageal feeder within 10 hours after birth (immediately if practical), then follow normal feeding program. Guaranteed Analysis: Bovine Globulin Protein (min.), 55 grams, Crude Protein (min.), 50%, Crude Fat (min.), 1%, Crude Fiber (max.), 0.5%, Bovine Albumin (min.), 19% Ingredients: Bovine serum, dried whey, lecithin, mineral oil, polyoxyethylene glycol (400) mono and dioleates, salt, potassium chloride, natural and artificial flavors, mag. sulfate.	024422	350 gram	Calf	Powder	\$18.69	Alta Genetics
	Calf Choice Total HiCal	This is an excellent source of IgG, colostrum fat, growth factors, and nutrients needed to improve calf survival, health, growth, and long term performance. HiCal may be used to supplement or completely replace maternal colostrum and easily mixes in under 15 seconds. To achieve a replacement dose, feed 1 bag (100g IgG) and for optimal calf performance feed 2 bags (200g IgG). If supplementing, feed a minimum of half a bag (50 g IgG) in addition to sufficient maternal colostrum to target a similar overall mass of IgG.	037630	700 gram	Calf	Powder	\$45.49	Alta Genetics
	Nutri-Drench	A natural, high-energy source containing vitamins, minerals, amino acids and glucose. These nutrients support life and are needed quickly to restore a non-functioning immune system. Feed and supplements normally require 8-14 hours for digestion. Nutri-Drench does not require digestion. It is the first and only oral supplement to rapidly absorb from the stomach directly to the bloodstream in minutes.	045762	32 oz	Cattle	Liquid	\$42.99	BoviDry Labs
			045906	Gallon	Cattle		\$111.99	
			040267	32 oz	Sheep		\$44.19	
	Bovine 1gG Replacer 115 grams	Made from natural bovine colostrum and is used to replace or supplement maternal colostrum as an aid in the treatment of Failure of Passive Transfer (FPT) in newborn calves.	501161	640 gram		Powder	\$41.19	
	Bovine 1gG 57 grams		501160	320 gram		Powder	\$19.89	







Digestive Health: Enzymes, Probiotics & Appetite Stimulants



	PRODUCT	DESCRIPTION	ITEM#	SIZE	SPECIES	FORM	PRICE	MFR.	
	Achieve Pro Paste	Achieve Pro Paste with cryptex help support calves through periods of stress when they are most vulnerable to disease.	038235	60 gm	Beef Dairy	Paste	\$17.19		
	Cattl Active	An all natural, prebiotic feed designed for use in cattle to support the digestive system during times of stress See more about this product on page 9.		250 ml			\$85.00		
				500 ml			\$140.00		
				1/2 Gallon			\$370.00		
				1 Gallon			\$725.00		
	Calf Recover	Scours can set a calf back in overall health & growth potential for the rest of its life. Calf Recover has 1) Egg Immunoglobulins (Antibodies) against E.coli, Bovine rotavirus, Salmonella, Clostridia, and Coronavirus 2) S. bouardii probiotic strain is the only one that can be used alongside antibiotics. 3) Prebiotics to feed the natural microbiome. 4) Lactase digestive enzymes break down milk sugars. 5) L-glutamine to feed the gut lining for better nutrient absorption.		12 count		Paste	\$314 (26.16 ea)		
				30 Serving Tub		Powder	\$187 (6.23 ea)		
	Calf Start	Calf Start has 1) Egg Immunoglobulins (Antibodies) against E.coli, Bovine rotavirus, Salmonella, Clostridia, Coronavirus 2) 5 Microbial Probiotic strains. 3) Important Fat-soluble vitamins A, D and E. against common disease causing pathogens. such as E.coli, Bovine rotavirus, Salmonella, Clostridia, Coronavirus to name a few.	201FBC A15GM	12 count	Bovine	Paste	\$138 (11.50 ea)	Livestock	
				60 Serving Tub		Powder	\$163 (5.42 ea)		
	First Arrival®	First Arrival with Encrypt™ helps bolster a calf's developing immune system during its first 14 days of life. Contains a combination of targeted proteins, microencapsulated lactic-acid-forming bacteria and unique carbon extract that can aid in addressing the pathogens that might cause malnutrition and scours in newborn calves. Contains no blood serum and is extremely digestible.	034651	60 gram	Calf	Paste	\$14.49	AgriLabs	
				032116	800 gram		Powder	\$122.19	
				034652	15 gram	Lamb	Paste	\$11.39	
	First Defense	Antibodies against E.coli & Coronavirus. Protects against the two major causes of scours in calves. Guaranteed antibody levels against K99 E.coli & Coronavirus, when administered to neonatal calves within 12 hours of birth	003935	5 per box	Calf		\$58.89		
				002412	30 per box			\$330.49	
				043406	30 gram		Gel Tubes	\$14.99	
	Nursemate ASAP	Appetite stimulator acidified paste for calves. Stimulates appetite to get the calf up and nursing. Initiates digestion and provides a specially balanced blend of lactic acid producing bacterial strains that compete against pathogens often found in the intestine.	026670	30 mL	Calf	Paste	\$11.89	Sterling	
				047594	30 mL	Lamb	Paste	\$12.29	



Digestive Health: Enzymes, Probiotics & Appetite Stimulants

	PRODUCT	DESCRIPTION	ITEM#	SIZE	SPECIES	FORM	PRICE	MFR.
	Probios® Bovine One Oral Gel for Ruminants	Contains a source of live (viable), naturally occurring microorganisms. Helps maintain a healthy microbial balance in animals, supplement desirable organisms in newborns, and help maintain appetite. For use in all ages of beef and dairy cattle, sheep and goats. Guaranteed to contain lactic acid bacteria (Enterococcus faecium, Lactobacillus acidophilus, Lactobacillus casei, Lactobacillus plantarum), not less than 10 million Colony Forming Units per gram.	003899	60 gram	Ruminants	Gel	\$16.19	
			003860	300 gram			\$49.69	
	Probios® Dispersible Powder	Contains a source of live (viable), naturally occurring microorganisms for beef and dairy cattle, horses, swine, sheep and goats. Dispense with fluids, in ration, or in milk replacer. Guaranteed to contain lactic acid bacteria (Enterococcus faecium, Lactobacillus acidophilus, Lactobacillus casei, Lactobacillus plantarum), not less than 10 million CFUs per gram.	002457	240 gram	Cattle/ Horse/ Sheep/ Swine/ Goat	Powder	\$20.59	
			007217	5 lb			\$91.39	
			030327	25 lb			\$325.49	
	Probios® Oral Boluses for Ruminants	Contains a source of live (viable), naturally occurring microorganisms. For use in all ages of beef and dairy cattle, as well as adult sheep and goats. Guaranteed to contain lactic acid bacteria (Enterococcus faecium, Lactobacillus acidophilus, Lactobacillus casei, Lactobacillus plantarum).	002422	1/4 oz. 50 count	Ruminants	Bolus	\$45.89	
			006677	1/2 oz. 50 count	Ruminants	Bolus	\$78.79	

Immune System Support

	PRODUCT	DESCRIPTION	ITEM#	SIZE	SPECIES	FORM	PRICE	MFR.
	Tri-Pectate	An all-natural nutritional supplement for calves that may help maintain the immune system. It is a convenient, one-time use product for individual calf administration. Contains pectins to assist in the digestive process; glucose to provide energy and improve absorption of electrolytes; and electrolytes to assist with replenishing fluid loss and restoring acid/base balance in the tissues.	035068	30 mL Single	Calf	Paste	\$8.99	Van Beek Natural Science
	FerAppease	An analogue of the Maternal Bovine Appeasing Substance (MBAS) for topical use in healthy cattle to mitigate the detrimental effects of stress.	117230 120831	300mL 1000mL	Bovine	Liquid	CALL FOR BEST PRICE	FERA









“WE WERE ASKED RECENTLY

why we still like our customers to call in to place an order. — The truth is, we’re a little bit old school. We find a great deal of value in hearing a voice on the other end of the line. We can work through herd management issues and talk about the best producer program that fits each operation. Of course, people are always welcome to email or text an order, but I have a strong feeling that we’ll prefer a phone call for years to come.”





—Tyler

Vitamins & Nutritionals: Targeted Deficiencies

PRODUCT	DESCRIPTION	ITEM#	SIZE	SPECIES	FORM	DEFICIENCY	PRICE	MFR.
 <p>CMPK Gel</p>	<p>Supplies calcium, magnesium, phosphorus and potassium to ensure normal levels in the blood before, during and after calving. Give one tube within 6–12 hours prior to calving. Give another tube within 6–12 hours after calving.</p> <p>Ingredients Calcium Chloride, Gel Base, Calcium Phosphate, Magnesium Chloride, Potassium Chloride</p> <p>Guaranteed Analysis Calcium (Ca), Min. 13.5% 54 g Calcium (Ca), Max. 15.0% 60 g Phosphorus (P), Min. 2.5% 10 g Magnesium (Mg), Min ... 0.725% ... 2.9 g Potassium (K), Min. 0.25% 1 g</p>	043860	300 mL	Cattle	Gel	Calcium, Magnesium, Phosphorus, Potassium	\$8.79	Generic
 <p>Lactipro®</p>	<p>A rumen-native probiotic consisting of a live, stable and naturally occurring proprietary strain of <i>Megasphaera elsdenii</i> (Mega e®) — a superior lactic acid utilizer. Lactipro helps cattle producers support healthy rumen pH and improve profitability by safely accelerating to finishing diets, reducing post-terminal processing mortality, and other benefits specific to the use cases of the operation.</p>		50 dose		drench			
			10 dose		drench			
			25 count		bolus			
 <p>Vitamin E-AD</p>	<p>A clear, sterile, non-aqueous solution of Vitamin A, Vitamin D3 and Vitamin E that is intended as a supplemental source of natural vitamins A, D and E in cattle. Each mL contains 100000 IU of Vitamin A, 10000 IU of Vitamin D3 and 300 IU of Vitamin E (as d-alpha-tocopherol). Also contains 20% ethyl alcohol and 1% benzyl alcohol (preservative) in an emulsifiable base.</p>	036919	250cc	Cattle	Injection	Vitamins A, D, E	\$57.89	Generic
 <p>Vitamin B Complex Injection</p>	<p>For use as a supplement source of B complex vitamins in cattle, horses, swine, sheep, dogs and cats. IM injection is recommended; may be administered SQ or IV. Each mL of sterile aqueous solution contains:</p> <ul style="list-style-type: none"> • Thiamine Hydrochloride (B1) 12.5 mg • Niacinamide 12.5 mg • Pyridoxine Hydrochloride (B6) 5 mg • d-Panthenol 5 mg • Riboflavin (B2) 2 mg • Cyanocobalamin (B12) 5 mcg • Citric Acid and Benzyl Alcohol 1.5% w/v as a preservative 	510217	100cc	Cattle/ Horse/ Sheep/ Swine/ Cat/Dog	Injection	B Vitamins	\$9.99	Generic
		510215	250cc				\$23.29	
		510216	500cc				\$33.69	
 <p>Multimin 90</p>	<p>Multimin 90 is a supplemental source of zinc, manganese, selenium and copper for cattle. Each ml of Multimin 90 is a chelated source of 60 mg zinc, 10 mg manganese, 5 mg selenium and 15 mg copper. Multimin 90 should be administered to cattle by SQ injection. The recommended dosage is 1 ml per 100 lbs body weight for calves up to 1 year of age; 1 ml per 150 lbs for cattle 1-2 years of age; and 1 ml per 200 lbs for cattle over 2 years of age. Frequency of administration may vary to suit management program. Zinc, manganese, selenium and copper.</p>		100ml	Cattle	Injection	Copper, Manganese, Selenium, Zinc	Rx	Multimin USA
			500ml				Rx CALL FOR BEST PRICE	



Anthelmintics

PRODUCT	ACTIVE INGREDIENT(S)	Ascarops strongylina (Stomach Worm)	Ascaris suum (Large Roundworm of Pigs)	Bunostomum spp (Hookworm)	Chabertia spp (Large Mouth Bowel Worm)	Cooperia spp (Small Intestine Worm)	Dictyocaulus (Lungworm)	Fasciola (Liver Flukes)	Haemonchus (Barberpole Worm)	Hyostongylus rubidus (Red Stomach Worm)	Marshallagia marshalli (Stomach Worm)	Metastrongylus (Lungworms)	Moniezia (Tapeworm)	Nematodirus spp.	Oesophagostomum spp. (Nodular Worms)	Oestrus ovis (Nasal Bot)
IVOMEC® Drench for Sheep 	Ivermectin 0.08%				S	S	S		S					S	S	S
Panacur®/ Safeguard Horse & Cattle Dewormer Suspension 	Fenbendazole 10%			C		C	C		C				C	C	C	
Safe-Guard® 0.5% Alfalfa-based Pellets 	Fenbendazole 5%			C		C	C		C	SW		SW		C	C,SW	
Safe-Guard® Beef & Dairy Cattle Dewormer 	Fenbendazole 10% (100 mg/g)			C		C	C		C					C	C	

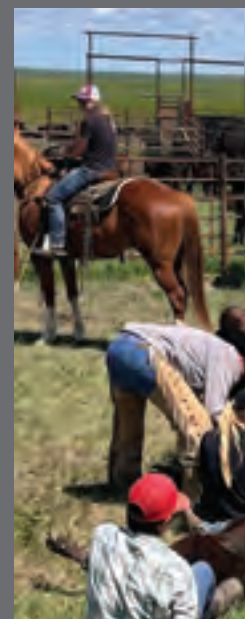

C = Cattle
 B = Beef Cattle
 D = Dairy Cattle





H = Horse
 S = Sheep
 SW = Swine

Psoroptes bovis (Mange Mites)	Sarcoptes scabiei (Mange Mites)	Solenopotes capillatus (Sucking Lice)	Stephanurus dentatus (Kidney Worm)	Strongyles, Large	Strongyles, Small	Strongyloides (Intestinal Threadworm)	Thysanosoma actinioides (Tapeworms)	Trichostrongylus (Small Stomach Worm)	Trichuris (Whipworm)	FORM	SPECIES	ITEM#	SIZE	PRICE	MFR.
S						S		S	S	Drench	Sheep	037101	1000 mL	\$114.99	Boehinger Ingelheim
												037887	4800 mL	\$396.09	
C	H	H		H	H			C		Suspension Suspension	Beef & dairy cattle; Horses; Do not use in veal calves	006634 009942	Liter Gallon	\$186.37 \$483.54	Merck
C			SW					C	SW	Top Dress Pellets	Beef, Dairy, Swine	003317	10 lb	\$68.99	Merck
C								C		Paste	Beef & dairy cattle	005402	290 gram	\$71.99	Merck





Anthelmintics

PRODUCT	ACTIVE INGREDIENT(S)	Ascarops strongylina (Stomach Worm)	Ascaris suum (Large Roundworm of Pigs)	Bunostomum spp (Hookworm)	Chabertia spp (Large Mouth Bowel Worm)	Cooperia spp (Small Intestine Worm)	Dictyocaulus (Lungworm)	Fasciola (Liver Flukes)	Haemonchus (Barberpole Worm)	Hyostromylus rubidus (Red Stomach Worm)	Marshallagia marshalli (Stomach Worm)	Metastrongylus (Lungworms)	Moniezia (Tapeworm)	Nematodirus spp.	Oesophagostomum spp. (Nodular Worms)	Oestrus ovis (Nasal Bot)
Safe-Guard® Horse & Cattle Dewormer 	Fenbendazole 10% (100 mg/g)			C		C	C		C					C	C	
Safe-Guard® Suspension 10% 	Fenbendazole 10% (100 mg/mL)			C		C			C,G					C	C	
Safe-Guard® Medicated Dewormer for Beef & Dairy Cattle 	Fenbendazole 1.96%			C		C	C		C					C	C	
Synanthic 22.5%	Oxfendazole 22.5%					C	C		C				C		C	
Valbazen® Suspension 	Albendazole 11.36% (113.6 mg/mL)			C	S	C,S	C,S	C, S, G	C,S		S		C, S	C,S	C,S	

VIEW THE DETYE CATALOG FROM YOUR PHONE!

Our website is mobile friendly. View or download the latest catalog to help with your animal health supplies list.

Visit Detye.com and follow us on **FACEBOOK** for up to date information and announcements.

C = Cattle
 B = Beef Cattle
 D = Dairy Cattle

H = Horse
 S = Sheep
 SW = Swine

Psoroptes bovis (Mange Mites)	Sarcoptes scabiei (Mange Mites)	Solenopotes capillatus (Sucking Lice)	Stephanurus dentatus (Kidney Worm)	Strongyles, Large	Strongyles, Small	Strongyloides (Intestinal Threadworm)	Thysanosoma actinioides (Tapeworms)	Trichostrongylus (Small Stomach Worm)	Trichuris (Whipworm)	FORM	SPECIES	ITEM#	SIZE	PRICE	MFR.
C	H	H		H	H			C		Paste	Beef & dairy cattle	034656	290 gram	\$71.99	Merck
											Horses		25 gram		
C,G								C		Suspension	Beef & dairy cattle, Goats (non-lactating); Do not use in veal calves	024345	Liter	\$175.99	Merck
							019072		Gallon			CALL FOR BEST PRICE			
							061853		10 Liter						
C								C		Flake Meal Soft Mini-Pellets	Beef & dairy cattle	014013	25 lb	CALL FOR BEST PRICE	Merck
									023784			50 lb			
								C		Suspension	Beef & dairy cattle	004053	500 mL	\$187.89	Boehringer Ingelheim
													1 Liter	\$299.89	
C,S							S	C, S		Suspension	Beef & dairy cattle; Goats; Sheep; Do not use in female dairy cattle of breeding age; Do not use in lactating does	000810	500 mL	\$56.22	Zoetis
									000947			Liter	\$97.11		
												004022	5 Liter	\$381.78	

DISCLAIMER

Because of ever-changing market prices & manufacturers programs, prices are subject to change without notice. You will be notified of all possible savings programs & price breaks to the best of our ability. We encourage you to call to discuss a program that would best fit your needs.

Because of the possibility of typographical or human error, DeTye disclaims responsibility for errors. DeTye also disclaims any responsibility for the use or misuse of products & the methods of use described in this catalog. The manufacturers label should always be followed. Purchasers & users should always follow their veterinarians recommendations.



LICE CONTROL

DULUTH, Ga. (September 16, 2020) — The old saying “scratch an itch” means to satisfy a desire or a need for something. While cattle producers have a need to grow healthy animals for a successful operation, lice are on a different track and ready to thwart that effort. They’re all about making animals miserable, affecting their health and performance.

A Nebraska study showed that a moderate to high lice population in feeder calves significantly decreased average daily gains (ADG) by 0.21 pounds in the untreated group of animals vs. those that were treated.¹ That affects more than just ADGs. One study estimated that losses to the cattle industry from lice are more than \$126 million annually.

“Lice can also affect milk production,” said David Boxler, one of the researchers from the Nebraska study. “What’s worse, what cattle experience with lice infestations, including cold stress, can set up the animal for other issues including respiratory problems and a generally higher susceptibility to other illnesses.”

Boxler is extension educator and livestock entomologist at the West Central Research and Extension Center for the University of Nebraska in North Platte. He’s passionate about finding ways to deliver effective parasite control and has been working with everything from prototypes of traps for stable flies to essential oils for cattle horn flies.

“We’re battling parasites without the promise of new parasiticide modes of action,” he said. “While we’re always searching for other unique options, it’s important to follow label directions and use the products we do have available correctly to enhance product efficacy.”

The best time may not be the most convenient. Ensuring the pour-on dewormer you’re using for external parasites like lice is effective includes applying it when it’s going to do the most good. That can be challenging with everything else going on at the ranch.

“For Northern states, cattle are brought in for weaning and processing in September and October,” Boxler explained. “Producers may think the dewormer they use at that time can take them through the winter and reduce lice populations. But our weather patterns are changing, and a warm fall means those lice aren’t even a threat yet.”

Lice hang out on an animal’s body all year long, but they’re sleepy in the summer. They tuck themselves inside folds of skin, between the legs and body; generally anywhere that’s protected from direct sunlight, in order to survive. As the weather gets colder and haircoats grow



longer, lice move up the animal’s body and feel protected enough to reproduce and lay eggs. But that sometimes doesn’t happen until late November or December. “If you’re treating parasites in the fall with an injectable dewormer, that’s not going to knock down a lice population because it’s not even there yet,” said Joe Gillespie, DVM, Boehringer Ingelheim. “Pour-on dewormers are the most effective for lice, and they should be timed right before the levels of parasites are at their highest. It’s important to discuss correct timing with your veterinarian to get this right for your operation.”

Dr. Gillespie noted that some producers may believe they’re seeing a reinfection in early winter, but if they applied a pour-on before the lice migrated to the top of the animal, the product wasn’t effective. “Lice populations, especially biting or chewing lice, can explode quickly once they start a new life cycle on the back and neck of the animal,” he explained.

“You can have a train wreck if you treat too early,” agreed Boxler. “Treat properly when it gets cold and is going to stay cold.”

Proper application makes all the difference. “Reading the product label is critical,” stressed Boxler. “Choose a product that is appropriate for the type of lice you have, know if you need more than one application spaced at a certain time interval, and ensure complete coverage.”

Complete coverage means taking the time to ensure a pour-on dewormer is distributed accurately. Carefully apply the product with an applicator gun along the midline (over the top of the back of each animal). Begin at the withers, and pour all the way down to the tailhead in a narrow strip to reduce runoff. Make sure the entire dose gets on the animal, not on the sides of the chute or on the handlers, to maximize efficacy.

“Sometimes an animal doesn’t receive the full dose because things can get chaotic, animals are running down the alley as fast as they can go and you want to get through the process quickly,” Boxler said. “But product ends up flying everywhere. Take the time to apply correctly and follow the label instructions because that will enhance product performance.”

The dosage, or amount of product applied, should also be adequate for the size and weight class of the animal being treated. Calculate the volume of pour-on product to be administered based on each animal’s weight, using a scale whenever possible. Weight tape or a cull weight slip are also options.

•Under-dosing: If an animal is under-dosed, the amount of the product’s active ingredient is not present in the animal’s tissues at the necessary level and the product

will not deliver the best lice control. Under-treatment will likely leave some of the parasites behind. That becomes problematic because the surviving parasites are potentially more likely to be resistant to subsequent and future treatments with products in the same class of dewormers.

•Over-dosing: When you over-dose animals, you waste hard-earned dollars on product.

Tell-tale signs of lice infestation

“Lice irritate the animal, which, in a mild case, can cause damage to the skin and a small amount of hair loss.



But if the infestation is heavy enough, it can cause real production and economic problems,” Gillespie said.

Cattle may spend all their time itching, scratching, licking and rubbing...instead of eating.

The key to identifying if your cattle have lice problems, Boxler says, is to look for signs of itching and rubbing. “An early, clear indicator is hairballs on fence lines. Look closer at your animals for patches of skin that appear raw and encrusted. Check multiple locations on multiple animals in the herd for red flags like this.”

If producers can get lice populations under control, cattle will overwinter better. They’ll grow a good hair coat for protection, steers will gain weight more efficiently and cows will be in better condition for spring calving. Properly applying a pour-on dewormer at the right time can help animals do all these things they’re supposed to do, without lice getting in the way.

Insecticides: Topical

PRODUCT	ACTIVE INGREDIENT(S)	INDICATIONS	FORM	SPECIES	ITEM#	SIZE	PRICE	MFR.
 Clean-Up	Permethrin and Diflubenzuron (IGR)	For control of both biting and sucking lice.	Pour on	For use on lactating & non lactating dairy cattle, beef cattle and calves			CALL FOR BEST PRICE	Bayer
 Inhibidor		Combination of an insect growth regulator, adulticide and synergist. Kills chewing and sucking lice, horn flies, stable flies, horse and deer flies on beef cattle and calves. Prevents the emergence of horn flies in the manure of treated cattle. Kills louse eggs before they hatch.	Pour on	For use on beef cattle & calves		0.5 gal 2.5 gal	CALL FOR BEST PRICE	
 Protectus	diflubenzuron, lambda-cyhalothrin, piperonyl butoxide	Kills chewing and sucking lice, horn flies, stable flies, horse flies, and deer flies on beef cattle and calves, louse eggs before they hatch. Season-long control of lice 0.5 gal bottle treats up to 64 head of cattle (1000 lbs per animal) 2.5 gal bottle treats up to 320 head of cattle (1000 lbs per animal)	Liquid	Cattle		2.5 Gallon	CALL FOR BEST PRICE	Neogen
Ultra Boss® Pour-On Insecticide	Permethrin 5%, piperonyl butoxide 5%	Controls flies and lice; season-long lice control with one application.	Pour on	For use on cattle, sheep, goats and horses.	019474	32 oz	\$42.32	Merck
					121358	5 Liter	\$207.97	
Ultra Saber® Pour-On	Lambdacyhalothrin 1%, piperonyl butoxide 5%	Controls horn flies and lice.	Pour on	Beef cattle and calves; Do not apply to lactating or dry dairy cows. Do not apply to face of beef cattle or calves. Not recommended for use on veal calves.	121357	32 oz	\$68.73	Merck
					121354	5 Liter	\$334.43	
Embargo Ultra	Lambdacyhalothrin 1%, piperonyl butoxide 5%	Controls horn flies and lice.	Pour on	May be applied to cattle at any time during the year	036477	Gallon	CALL FOR BEST PRICE	



Endectocides

	ACTIVE INGREDIENT(S)	ACTIVE INGREDIENT(S)	Ascaris suum (Large Roundworm of Pigs)	Bovicola (Lice)	Bunostomum spp (Hookworm)	Chorioptes (Mange Mites)	Cooperia spp (Small Intestine Worm)	Damalinia (Biting Lice)	Dictyocaulus (Lungworm)	Fasciola (Liver Flukes)	Haemonchus (Barberpole Worm)	Haematobia irritans (Horn Flies)	Haematopinus (Sucking Lice)	Hyostrogylus rubridus (Red Stomach Worm)	Hypoderma (Cattle Grubs)	Linognathus vituli (Sucking Lice)	Metastrongylus (Lungworms)	Nematodirus spp.
	Cydectin® Injectable Solution	Moxidectin 1% (10 mg/mL)					C		C		C				C			C
	Dectomax® Injectable Solution 1%	Doramectin 1% (10 mg/mL)	SW		C		C		C		C		C,SW	SW	C	C	SW	
	IVOMEC® 1% Injection for Cattle & Swine	Ivermectin 1% (10mg/mL)	SW		C		C		C				C,SW	SW	C	C	SW	C
	IVOMEC® Plus Injection for Cattle	Ivermectin 1% (10mg/mL), Clorsulon 10% (100mg/mL)			C		C		C	C	C		C		C	C		C
	LongRange Injection for Cattle RX				C	C	C	C	C		C	C	C		C	C		C
	Vetrimect™ 1% Injection for Cattle & Swine	Ivermectin 1% (10mg/mL)	SW		C		C		C		C		C,SW	SW	C	C	SW	C
	Vetrimect™ PLUS	Ivermectin 1%, Clorsulon 10%			C		C		C	C	C		C		C	C		C
	Cydectin® Oral Drench for Sheep	Moxidectin 0.1% (1 mg/mL)					S				S							S

Oesophagostomum spp. (Nodular Worms)	Ostertagia (Brown Stomach Worm)	Psoroptes bovis (Mange Mites)	Sarcoptes scabiei (Mange Mites)	Solenopotes capillatus (Sucking Lice)	Stephanurus dentatus (Kidney Worm)	Strongyloides (Intestinal Threadworm)	Teladorsagia	Thelazia (Eye Worm)	Trichostrongylus (Small Stomach Worm)	Trichuris (Whipworm)	C = Cattle H = Horse			B = Beef Cattle S = Sheep		D = Dairy Cattle SW = Swine	
											FORM	SPECIES	ITEM#	SIZE	PRICE	MFR.	
C	C	C		C					C		Injectable	Beef & dairy cattle older than 8 weeks; Do not use in veal calves; Do not use in female dairy cattle of breeding age or lactating	027081	200cc	CALL FOR BEST PRICE	Bayer	
										Injectable Gun		027082	500cc				
												027083					
C,SW	C	C	C,SW	C	SW	SW		C	C	C	Injectable	Beef cattle; Dairy cattle older than 20 months; Do not use in veal calves	013334	100cc	\$70.81	Zoetis	
													034403	200cc	\$146.96		
													013336	500cc	CALL FOR BEST PRICE		
C,SW	C	C	C,SW	C		SW			C		Injectable	Beef & dairy cattle; Swine; Do not use in veal calves; Do not use in female dairy cattle of breeding age	004831	50cc	CALL FOR BEST PRICE	Boehinger Ingelheim	
													009744	200cc			
													018480	500cc			
													019041	Liter			
C	C	C	C	C					C		Injectable	Beef & dairy cattle; Do not use in veal calves; Do not use in female dairy cattle of breeding age	010076	50cc	CALL FOR BEST PRICE	Boehinger Ingelheim	
													010077	200cc			
													010078	500cc			
													019042	Liter			
											Injector Gun		019701	12.5 mL			
C	C		C	C		C			C	C				250cc	CALL FOR BEST PRICE	Boehinger Ingelheim	
														500cc			
C,SW	C	C	C,SW	C		SW			C		Injectable	Beef & dairy cattle; Swine; Do not use in veal calves; Do not use in female dairy cattle of breeding age	501034	50cc	CALL FOR BEST PRICE	Generic	
													504034	500cc			
C	C	C	C	C			S		C		Injectable	Beef & dairy cattle; Do not use in veal calves; Do not use in female dairy cattle of breeding age	504035	500cc	CALL FOR BEST PRICE	Generic	
S									S		Drench	Sheep not providing milk for human consumption	027084	Liter	CALL FOR BEST PRICE	Bayer	
													027085	4 Liter			



Endectocides

	PRODUCT	ACTIVE INGREDIENT(S)	Ascaris suum (Large Roundworm of Pigs)	Bovicola (Lice)	Bunostomum spp (Hookworm)	Chorioptes (Mange Mites)	Cooperia spp (Small Intestine Worm)	Damalina (Biting Lice)	Dictyocaulus (Lungworm)	Fasciola (Liver Flukes)	Haemonchus (Barberpole Worm)	Haematobia irritans (Horn Flies)	Haematopinus (Sucking Lice)	Hyostromylus rubidus (Red Stomach Worm)	Hypoderma (Cattle Grubs)	Linognathus vituli (Sucking Lice)	Metastrongylus (Lungworms)	Nematodirus spp.
	Cydectin® Pour-On	Moxidectin (5 mg/mL)		C	C	C	C		C		C	C	C		C	C		C
	Dectomax® Pour-On	Doramectin 0.5% (5 mg/mL)			C	C	C	C	C		C	C	C		C	C		
	Dectogard	Doramectin 1%			C	C	C	C	C		C	C	C		C	C		
	Eprigard	Eprinomectin			C	C	C	C	C		C	C	C		C	C		C
	Eprizero	Eprinomectin			C	C	C	C	C		C	C	C		C	C		C
	IVOMECEPRINEX® Pour-On for Beef & Dairy Cattle	Eprinomectin (5 mg/mL)			C	C	C	C	C		C	C	C		C	C		C
	IVOMECE® Pour-On for Cattle	Ivermectin (5 mg/mL)					C	C	C		C	C	C		C	C		
	Vetrimex™ Pour-On for Cattle	Ivermectin (5 mg/mL)					C	C	C		C	C	C		C	C		
	Tauramox	Moxidectin 1%		C	C	C	C		C		C	C	C		C	C		C
	Valcor RX Only	Doramectin, Levamisole Hydrochloride	SW		C		C		C		C	C, SW	SW	C	C		SW	

Oesophagostomum spp. (Nodular Worms)	Ostertagia (Brown Stomach Worm)	Psoroptes bovis (Mange Mites)	Sarcoptes scabiei (Mange Mites)	Solenopotes capillatus (Sucking Lice)	Stephanurus dentatus (Kidney Worm)	Strongyloides (Intestinal Threadworm)	Teladorsagia	Thelazia (Eye Worm)	Trichostrongylus (Small Stomach Worm)	Trichuris (Whipworm)	FORM	C = Cattle H = Horse			B = Beef Cattle S = Sheep		D = Dairy Cattle SW = Swine	
												SPECIES	ITEM#	SIZE	PRICE	MFR.		
C	C	C		C					C		Pour On	Beef & dairy cattle; Do not use in veal calves	014329	500cc	CALL FOR BEST PRICE	Bayer		
											014330		Liter					
											014331		2.5 Liter					
											014525		5 Liter					
											017788		10 Liter					
C	C		C	C				C	C	C	Pour On	Beef cattle; Dairy cattle older than 20 months; Do not use in veal calves	014119	250 mL		Zoetis		
											014120		Liter					
											014121		2.5 Liter					
											027176		5 Liter Case of 2					
C	C		C	C				C	C	C	Pour On	Cattle	119730	2.5 Liter		Aurora		
C	C		C	C		C			C	C	Liquid	Cattle	120196	5 Liter		Aurora		
C	C		C	C		C			C	C	Spray	Beef & dairy cattle	090439	5 Liter		Norbrook		
C	C		C	C		C			C	C	Pour On	Beef & dairy cattle	013982	250 mL		Boehinger Ingelheim		
											013983		Liter					
											015439		2.5 Liter					
											014038		5 Liter					
C	C		C	C		C			C	C	Pour On	Beef & dairy cattle; Do not use in veal calves; Do not use in female dairy cattle of breeding age	018454	250cc		Boehinger Ingelheim		
											018453		Liter					
											002013		2.5 Liter					
											027178		5 Liter Case of 2					
C	C		C	C		C			C	C	Pour On	Beef & dairy cattle; Do not use in veal calves; Do not use in female dairy cattle of breeding age	503001	5 Liter Box of 2				
											Pour-On Gun		505001					
C	C	C		C					C		Injectable	Cattle		500 mL		Norbrook		
C, SW	C	C	C, SW	C	SW	SW		C	C	C	Injectable	Cattle	121375	500 mL		Zoetis		

"FARMERS AND RANCHERS
are the BACKBONE OF OUR BUSINESS;
and we could not pick better people to work with."



CATL

RESOURCES

Contact Us About New and Used

**SILENCER Chutes, DANIELS Mfg. Equipment,
Portable Corral Systems & Continuous Fence.**

NEW
Wide Body Chute
Available



**Inventory
Available!**

*We Sell The Best Because
We've Used the Rest!*



**Tim Olson & Chandy Olson, DVM
605.641.5966 or 605.641.2325
www.catlresources.com**

VETERINARY INSECTICIDE EAR TAG COMPARISON

DESCRIPTIONS AND PRODUCT PRICING – PAGE 62-63

BRAND	MFR.	ACTIVE INGREDIENT	COLOR	APPLICATOR	WEIGHT	DURATION	LACTATING DAIRY	TAGS/UNIT	PRODUCT #
MACROCYCLIC LACTONE									
XP 820	Y-TEX	8% Abamectin/20% Piperonyl Butoxide	Yellow	Y-TEX	9g	Up to 5 Months	•	20	034180
XP 820	Y-TEX	8% Abamectin/20% Piperonyl Butoxide	Yellow	Y-TEX	9g	Up to 5 Months	•	100	034181
ORGANOPHOSPHATE TAGS									
CORATHON	Bayer	15% Coumaphos/35% Diazinon	Slate	Allflex	14g	Up to 5 Months		20	
DOMINATOR	Merck	20% Pirimiphos Methyl	Yellow	Allflex	9.5g	Up to 5 Months		20	
OPTIMIZER	Y-TEX	20% Diazinon	Red-Orange	Y-TEX	15g	Up to 5 Months		20	
OPTIMIZER	Y-TEX	20% Diazinon	Red-Orange	Y-TEX	15g	Up to 5 Months		100	
PATRIOT	Bayer	40% Diazinon	Orange	Allflex	15g	3-5 Months		20	
PATRIOT	Bayer	40% Diazinon	Orange	Allflex	15g	3-5 Months		120	
WARRIOR	Y-TEX	30% Diazinon/10% Chlorpyrifos	Green	Y-TEX	15g	Up to 5 Months		20	
WARRIOR	Y-TEX	30% Diazinon/10% Chlorpyrifos	Green	Y-TEX	15g	Up to 5 Months		100	
PYRETHROID TAGS									
CYLENCE ULTRA	Bayer	80g/kg Betacyfluthrin 200g/kg Piperonyl Butoxide	Blue	Allflex	14g	Up to 5 Months	•	20	
GARDSTAR PLUS	Y-TEX	10% Permethrin	Red	Y-TEX	9.5g	4-5 Months	•	25	
PYTHON	Y-TEX	10% Zeta-Cypermethrin/20% Piperonyl Btx	Purple	Y-TEX	9.5g	4-5 Months	•	20	
PYTHON	Y-TEX	10% Zeta-Cypermethrin/20% Piperonyl Btx	Purple	Y-TEX	9.5g	4-5 Months	•	100	
PYTHON MAGNUM	Y-TEX	15.4 Gram Zeta-Cypermethrin	Blue	Y-TEX	15g	4-5 Months	•	20	
PYTHON MAGNUM	Y-TEX	15.4 Gram Zeta-Cypermethrin	Blue	Y-TEX	15g	4-5 Months	•	100	
SABER EXTRA	Merck	10% Lambdacyhalothrin	Blue	Allflex	9.5g	Up to 5 Months		20	
COMBO TAGS									
DOUBLE BARREL	Merck	6.8% Lambdacyhalothrin/14% Pirimiphos	Red	Allflex	9.5g	Up to 5 Months		20	
TRI-ZAP	Y-TEX	3.2% Zeta-Cypermethrin/6% Abamectin & 20% Piperonyl Butoxide	Turquoise	Y-TEX	9.5g	Up to 4 Months	•	20	
TRI-ZAP	Y-TEX	3.2% Zeta-Cypermethrin/6% Abamectin & 20% Piperonyl Butoxide	Turquoise	Y-TEX	9.5g	Up to 4 Months	•		





Insecticide Applicator Gun

	PRODUCT	DESCRIPTION	ITEM#	PRICE
	Vet Cap Applicator Gun	The VetGun uses precision-engineered CO2 power to project a precise dosage of AiM-L VetCap to treat the animal, without any handling at all. The VetCap is a patented new dosage form that encapsulates liquid parasiticides in a special softgel capsule. It is delivered using SmartVet's VetGun delivery system. The VetGun is designed to fire the VetCaps out to a range of about 30 feet. The VetCap bursts on the cow, releasing its contents; the formulation then goes to work in a similar way to pour-on products. The VetGun and VetCaps are engineered not to startle the cattle, and minimize any discomfort caused by the dosing process. Includes two adaptors, allowing use with both 25 gm and 90 gm CO2 propellant cartridges.	039363	\$353.99

Insecticides: Ear Tags

	PRODUCT		ACTIVE INGREDIENT(S)	INDICATIONS
Organophosphate/ Pyrethroid		Double Barrel™ VP Ear Tags	Pirimiphos methyl 14%, lambdacyhalothrin 6.8%	Controls horn flies and face flies.
Macrocyclic Lactone		XP 820™ Ear Tags	Piperonyl butoxide 20%, abamectin (avermectins B1a and B1b) 8%	Controls horn flies, gulf coast ticks and spinose ear ticks. Aids in control of American dog ticks, cattle fever ticks (boophilus species), lone star ticks, and reduces face flies.
Organophosphate		Corathon	15% Coumaphos/35% Diazinon	Controls face flies, horn flies, Gulf Coast tics and Spinose ear tics
		Dominator® Ear Tags	Pirimiphos methyl 20%	Controls Horn flies (including synthetic pyrethroid-resistant Horn flies). Aids in Control of Face flies.
		Patriot™ Ear Tags	Diazinon 40%	Controls horn flies and ear ticks. Aids in the control of face flies, lice, stable flies and house flies.
		Max 40 Ear Tags	Organophosphate, Diazinon 40%	Controls horn flies, gulf coast ticks, and spinose ear ticks. Aids in control with face flies, lice, stable flies, and house flies. These tags are applied with the Ultra Tagger Plus Applicator.
Pyrethroid		Cylence Ultra Ear Tags	Beta-cyfluthrin 15% (pyrethroid)	Control face flies, horn flies, gulf coast ticks and ear ticks.
		GardStar® plus Ear Tags	Permethrin 10%	Controls pyrethroid-susceptible horn flies, face flies, gulf coast ticks, and ear ticks. Aids in control of stable flies, house flies, and lice.
		PYthon™ Ear Tags	Zeta-cypermethrin 10%, piperonyl butoxide 20%	Controls horn flies, face flies, lice, gulf coast ticks and ear ticks. Aids in control of stable flies, black flies, house flies and small horse flies.
		PYthon® MAGNUM Ear Tags	Piperonyl butoxide 20%, zeta-cypermethrin 10%	Controls horn flies and biting lice. Aids in control of face flies, stable flies, house flies and sucking lice.
		Saber™ Extra Ear Tags	Piperonyl butoxide 13%, lambdacyhalothrin 10%	Controls horn flies and face flies.
		Tri-Zap Ear Tags	3.2% Zeta-Cypermethrin/6.0% Abamectin/20% Piperonyl Buto	Control of horn, face flies, lice and spinose ear ticks

	PRODUCT	DESCRIPTION	UNIT	ITEM#	PRICE
	Aim-A Caps	30 count, 150 count The AiM VetCap™ (Advanced Insecticide Management) is a purpose designed gelatin capsule, filled with EPA approved cattle Parasiticide, and projected from a CO2-powered VetGun.	30 ct	064265	\$88.09
			150 ct	064266	\$430.99
	Aim-L Caps	30 count, 150 count NEW AiM-A™ (Abamectin) is the first Macrocytic Lactone class of VetCaps available for the control of horn flies and lice on beef cattle. Rotating AiM-L and AiM-A treatments can help prevent hornfly resistance, one of the biggest issues facing the cattle industry.	30 ct	048597	\$70.19
			150 ct	051114	\$335.59

SPECIES	WEIGHT	COLOR	TAGGER	ITEM#	UNIT	PRICE	MFR.
Beef & non-lactating dairy cattle & calves	9.5 gr	Red	ALLFLEX	012491	Pack of 20	CALL FOR BEST PRICE	Merck
Beef & non-lactating dairy cattle & calves	9 gr	Metallic gold	Y-TEX	034180	Pack of 20		Y-Tex
				034181	Pack of 100		
Beef & non-lactating dairy cattle & calves	14 gr	Slate	ALLFLEX	035840	Pack of 20		Bayer
Beef & non-lactating dairy cattle & calves	9.5 gr	Yellow	ALLFLEX	011501	Pack of 20		Merck
Beef & non-lactating dairy cattle	15 gr	Orange	ALLFLEX	001733	Pack of 120		KMG Chemicals
				001739	Pack of 20		
Beef & non-lactating dairy cattle & calves	15 gr	Green	Y-TEX	020150	Pack of 20		Y-Tex
				021782	Pack of 100		
Beef & dairy cattle including calves & lactating dairy cows	14 gr	Clay	ALLFLEX	021095	Pack of 20		Bayer Animal Health
Beef & dairy cattle including calves & lactating dairy cows	9.5 gr	Reddish-orange	Y-TEX	012641	Pack of 25		Y-Tex
Beef & dairy cattle including calves & lactating dairy cows	9.5 gr	Purple	Y-TEX	021780	Pack of 20		Y-Tex
				021781	Pack of 100		
Beef & dairy cattle including calves & lactating dairy cows	15.4 gr	Bright blue	Y-TEX	021778	Pack of 20		Y-Tex
				021779	Pack of 100		
Beef & non-lactating dairy cattle & calves	9.5 gr	Purple	ALLFLEX	011503	Pack of 20		Merck
		Turquoise	Y-Tex	065868	Pack of 20	Y-Tex	
				065869	Pack of 100		

DETYE FUNDAMENTAL VALUES:

- * Provide our ranching customers with the lowest prices on quality animal health products
- * Provide our customers with the most updated information on those products, so they can make the best decision for their individual livestock needs
- * Deliver those products in the most efficient way possible, with the least amount of hassle on the customers end.

DeTye
DETYE VET SUPPLY, INC

Open Spaces Photography

Anticoccidials

PRODUCT	DESCRIPTION	ACTIVE INGREDIENT(S)	ITEM#	STRENGTH/ SIZE	PRICE	MFR.
Corid® 20% Powder	A Type C Medicated Feed (coccidiostat) for use as an aid in the prevention and treatment of coccidiosis caused by Eimeria bovis and E. zurnii in calves. The product is packaged in resealable plastic bags and is designed to be top-dressed on cattle feed.	Amprolium	000376	10oz	CALL FOR BEST PRICE	
Corid Solution 9.6%		Amprolium	000372	Gallon		

Antidiarrheals

PRODUCT	DESCRIPTION	ACTIVE INGREDIENT(S)	ITEM#	STRENGTH/ SIZE	PRICE	MFR.
Bolisorb™ Jr.	Adsorbent anti-diarrheal demulcent bolus (10 mg) for use as an aid in relief of simple non-infectious diarrhea in calves and foals.	Attapulgite clay, kaolin	520047	10 mg Jar of 50	\$12.19	Generic
Bolisorb™ Max	Adsorbent anti-diarrheal demulcent bolus (20 mg) for use as an aid in relief of simple non-infectious diarrhea in adult cattle and horses as well as in calves and foals older than 3 weeks.	Attapulgite clay, kaolin	510290	20 mg Jar of 50	\$15.99	Generic
Endosorb™ Bolus	Absorbent anti-diarrheal demulcent for supportive treatment of intestinal disturbances affecting cattle, calves, horses and colts. Contains activated attapulgite.	Activated attapulgite	002192	240 gram Box of 50	\$68.49	PRN Pharmacial
			007270	1.5 gram Box of 500	\$110.99	
EPIC Calf Scour Formula with Immune Support	For calves older than 24 hours. Contains a combination of recognized ingredients proven to be of critical importance for scouring calves. The patented EPIC (Egg Protein In Complexes) base provides specific immunoglobulins (IgYs) and other immune cofactors.		063369	2.2 lb pail	\$123.79	Tomlyn Vet





CATTLE IMPLANT COMPARISON CHART

DESCRIPTIONS AND PRODUCT PRICING – PAGE 66-67

BRAND	MFR.	ESTRADIOL (MG)	ESTRADIOL BENZOATE (MG)****	PROGESTERONE (MG)	TESTOSTERONE PROPIONATE (MG)	TRENBOLONE ACETATE (MG)	INDICATIONS*	ITEM #
COMPONENT® E-C WITH TYLAN®** R_x ONLY	ELANCO		10	100			Suckling beef calves up to 400 lbs; do not use in bull calves intended for reproduction or in calves <45 days old	015449
COMPONENT® TE-200 WITH TYLAN®**	ELANCO	20				200	Steers and heifers fed in confinement for slaughter	031283
COMPONENT® TE-G WITH TYLAN®** R_x ONLY	ELANCO	8				40	Pasture cattle (slaughter, stocker, feeder steers and heifers)	015453
COMPONENT® TE-IH WITH TYLAN®** R_x ONLY	ELANCO	8				80	Heifers fed in confinement for slaughter	023253
COMPONENT® TE-IS WITH TYLAN®**	ELANCO	16				80	Steers fed in confinement for slaughter	023254
COMPONENT® T-H WITH TYLAN®**	ELANCO					200	Feedlot heifers	015110
COMPUDOSE®***	ELANCO	25.7					Suckling and pastured growing steers, confined steers and heifers	008952
ENCORE®***	ELANCO	43.9					Suckling and pastured growing steers, confined steers and heifers	015165
FINAPLIX®-H	MERCK					200	Heifers fed in confinement for slaughter	084600 (drop ship only)

* Do not use these products in veal calves. Refer to label for complete directions for use, precautions and warnings.

**Available with 29 mg tylosin tartrate added as a local antibacterial (Component with Tylan products).

***Available with 0.5 mg oxytetracycline antibacterial coating (Compudose and Encore).

****Estradiol Benzoate converts to an equivalent dose of Estradiol using the conversion rate of E2 = 0.724 x EB.°

ALWAYS READ AND FOLLOW LABEL DIRECTIONS.

AmerisourceBergen



BRAND	MFR.	ESTRADIOL (MG)	ESTRADIOL BENZOATE (MG)*****	PROGESTERONE (MG)	TESTOSTERONE PROPIONATE (MG)	TRENBOLONE ACETATE (MG)	ZERANOL (MG)	INDICATIONS*	ITEM #
RALGRO®	MERCK						36	Suckling beef calves, weaned and growing beef cattle, feedlot steers and heifers; approved for use in replacements between 1 month of age and weaning; not approved for use in dairy cattle or bulls intended for reproduction	007279
REVALOR® 200	MERCK	20				200		Steers and heifers fed in confinement for slaughter	019378
REVALOR® -G	MERCK	8				40		Pasture cattle (slaughter, stocker, feeder steers and heifers)	019820
REVALOR® -H	MERCK	14				140		Heifers fed in confinement for slaughter	013613
REVALOR® -IH	MERCK	8				80		Heifers fed in confinement for slaughter	019777
REVALOR® -IS	MERCK	16				80		Steers fed in confinement for slaughter	019776
REVALOR® -S	MERCK	24				120		Steers fed in confinement for slaughter	013611
REVALOR® -XH	MERCK	20				200		Heifers fed in confinement for slaughter	065642
REVALOR® -XS	MERCK	40				200		Steers fed in confinement for slaughter	034600
SYNOVEX® C	ZOETIS		10	100				Suckling beef calves, 45 days or older, up to 400 lbs	019348
SYNOVEX® CHOICE	ZOETIS		14			100		Feedlot steers and heifers fed in confinement for slaughter	021552
SYNOVEX® H	ZOETIS		20		200			Stocker and feedlot heifers weighing 400 lbs or more	006724
SYNOVEX® ONE FEEDLOT	ZOETIS		28			200		Feedlot steers and heifers fed in confinement for slaughter	062442
SYNOVEX® ONE GRASS	ZOETIS		21			150		Pasture steers and heifers (slaughter, stocker, feeder)	062443
SYNOVEX® PLUS	ZOETIS		28			200		Steers and heifers fed in confinement for slaughter	012600
SYNOVEX® S	ZOETIS		20	200				Stocker and feedlot steers weighing 400 lbs or more	006725



Antidiarrheals

PRODUCT	DESCRIPTION	ACTIVE INGREDIENT(S)	ITEM#	STRENGTH/ SIZE	PRICE	MFR.
Kaolin Pectin 4 Suspension 	A time-tested formula for use as an aid in the treatment of noninfectious diarrhea in horses, cattle, dogs and cats. Combines pectin with kaolin (also known as china clay) in a palatable flavored vehicle. Each fluid ounce (2 tablespoonfuls) contains: <ul style="list-style-type: none"> • Kaolin, 90 gr. (5.8 g) • Pectin, 4 gr. (0.268 g) 	Kaolin, pectin	510227	Gallon	\$13.99	Generic

Implants

PRODUCT	DESCRIPTION	ACTIVE INGREDIENT(S)	ITEM#	SIZE	PRICE	MFR.
Component TEG 	Implant for weaned pasture steers, heifers and spayed heifers. Should not be used in dairy animals or in animals intended for subsequent breeding. Contains 40 mg trenbolone acetate and 8 mg estradiol. No slaughter withdrawal.	Trenbolone Acetate 40 mg Estradiol USP 8 mg	015453	100 Dose	CALL FOR BEST PRICE	Elanco
Component E-C w/ Tylan Rx Only 	For increased rate of weight in suckling beef calves up to 400 lb. approx.	Progesterone USP 100 mg Estradiol benzoate 10 mg	015449	100 Dose		
Ralgro® Implants (Cattle) 	Used to increase the rate of weight gain and improve feed conversion in suckling beef calves, including replacement heifers between one month of age and weaning, weaned beef calves, growing beef cattle, feedlot steers and feedlot heifers. Contains zeranol, an anabolic agent that has a positive influence on the dynamic state of protein metabolism in the animal.	Zeranol	007279	24 Dose	\$51.99	Merck

DISCLAIMER

Because of ever-changing market prices & manufacturers programs, prices are subject to change without notice. You will be notified of all possible savings programs & price breaks to the best of our ability. We encourage you to call to discuss a program that would best fit your needs.

Because of the possibility of typographical or human error, DeTye disclaims responsibility for errors. DeTye also disclaims any responsibility for the use or misuse of products & the methods of use described in this catalog. The manufacturers label should always be followed. Purchasers & users should always follow their veterinarians recommendations.

We give volume discounts! Call us to find out if your order will qualify.
866-438-7541

PRODUCT	DESCRIPTION	ACTIVE INGREDIENT(S)	ITEM#	SIZE	PRICE	MFR.
 Revalor®-200	Contains 200 mg of trenbolone acetate and 20 mg estradiol. For steers and heifers fed in confinement for slaughter.	Trenbolone acetate, estradiol	019378	Box of 100	\$428.57	Merck
 Revalor®-G	Contains 40 mg of trenbolone acetate and 8 mg estradiol. For pasture cattle (slaughter, stocker and feeder steers and heifers).	Trenbolone acetate, estradiol	019820	Box of 100	\$197.14	
 Revalor®-H	Contains 140 mg of trenbolone acetate and 14 mg estradiol. For heifers fed in confinement for slaughter.	Trenbolone acetate, estradiol	013613	Box of 100	\$428.57	
 Revalor®-IH	Contains 80 mg of trenbolone acetate and 8 mg estradiol. For heifers fed in confinement for slaughter.	Trenbolone acetate, estradiol	019777	Box of 100	\$351.54	
 Revalor®-IS	Contains 80 mg of trenbolone acetate and 16 mg estradiol. For steers fed in confinement for slaughter.	Trenbolone acetate, estradiol	019776	Box of 100	\$351.54	
 Revalor®-S	Contains 120 mg of trenbolone acetate and 24 mg estradiol. For steers fed in confinement for slaughter.	Trenbolone acetate, estradiol	013611	Box of 100	\$428.57	
 Revalor®-XS	Revalor-XS is the first delayed-release combination implant. Each implant contains 10 pellets: 4 uncoated and 6 coated with X7™ polymer. The first dose goes to work immediately after implant, just like Revalor-IS. The second dose, shielded by the patented X7 polymer coating, goes to work after 70-80 days on feed – delivering the performance of a Revalor-S terminal implant. Each pellet contains 20 mg of trenbolone acetate and 4 mg of estradiol for a total dose of 200 mg of trenbolone acetate and 40 mg of estradiol. For steers fed in confinement for slaughter.	Trenbolone acetate, estradiol	034600	Box of 100	\$1001.22	
 Synovex® C	Calf implants for increased rate of weight gain. One dose of 4 pellets contains 100 mg progesterone and 10 mg estradiol benzoate per implantation. Do not use in veal calves, bull calves intended for reproduction, or calves younger than 45 days.	Progesterone, estradiol benzoate	019348	Box of 100	\$160.26	Zoetis
 Synovex® Choice	A growth-promoting implant for steers fed in confinement for slaughter. Contains 100 mg of trenbolone acetate and 14 mg of estradiol benzoate. Each implant consists of 4 pellets. Ten implants are provided in each cartridge.	Trenbolone acetate, estradiol benzoate	021552	Box of 100	\$389.00	
 Synovex® H	For increased rate of weight gain and improved feed efficiency in heifers. One dose of 8 pellets contains 200 mg testosterone propionate and 20 mg estradiol benzoate per implantation.	Testosterone propionate, estradiol benzoate	006724	100 Dose	\$160.26	
 Synovex One Feedlot	For steers and heifers fed in confinement for slaughter. Contains 200mg of trenbolone acetate, 28mg of estradiol benzoate and consists of 8 pellets.	Trenbolone acetate, estradiol benzoate		100 Dose	\$933.85	
 Synovex One Grower	For pasture steers and heifers (slaughter, stocker & feeder), 150mg of trenbolone acetate, 21mg of estradiol benzoate	Trenbolone acetate, estradiol benzoate		6 Pellets	\$617.44	
 Synovex® Plus™	A growth-promoting implant containing 200 mg of trenbolone acetate and 28 mg of estradiol benzoate. Each implant consists of 8 pellets. Ten implants are provided in each cartridge. Recommended for increased rate of weight and improved feed efficiency in steers and for increased rate of weight gain in heifers fed in confinement for slaughter.	Trenbolone acetate, estradiol benzoate	012600	100 Dose	\$460.33	
 Synovex® S	Steer implants for increased rate of weight gain and improved feed efficiency. One dose of 8 pellets contains 200 mg progesterone and 20 mg estradiol benzoate per implantation.	Progesterone, estradiol benzoate	006725	100 Dose	\$160.26	





Hormones & Analogs: Progestins

PRODUCT	DESCRIPTION	ACTIVE INGREDIENT(S)	ITEM#	SIZE	PRICE	MFR.
EAZI-Breed™ CIDR® Cattle Insert 	The EAZI-Breed CIDR Cattle Insert provides an exogenous source of progesterone during the 7-day administration period to facilitate synchronization of estrus in suckled beef cows, and replacement beef and dairy heifers, advancement of first postpartum estrus in suckled beef cows; advancement of first pubertal estrus in replacement beef heifers; and synchronization of the return to estrus in lactating dairy cows inseminated at the immediately preceding estrus. Each insert contains 1.38 grams of progesterone in molded silicone over a flexible nylon spine. Administer intravaginally using the specially designed applicator (blue for dairy cows, green for beef cows).	Progesterone	021274	Insert Box of 10	CALL FOR BEST PRICE	Zoetis
			021285	Insert Applicator Blue (dairy)	\$15.69	
			021304	Insert Applicator (beef)	\$15.69	

Hormones & Analogs: Gonadotropins

All Rx items require veterinarian prescription.







PRODUCT	DESCRIPTION	ACTIVE INGREDIENT(S)	ITEM#	STRENGTH	SIZE	PRICE	MFR.
 Cystorelin® Rx	Gonadorelin (GnRh) diacetate tetrahydrate in a sterile solution suitable for IM or IV administration. Indicated for the treatment of ovarian follicular cysts in dairy cattle.	Gonadorelin (GnRH) diacetate tetrahydrate	007635	50 mcg/mL	10cc	CALL FOR BEST PRICE	Boehringer Ingelheim
 Factrel® Rx	Gonadorelin hydrochloride, indicated for the treatment of ovarian follicular cysts in cattle.	Gonadorelin (GnRH) diacetate tetrahydrate	002450	50 mcg/mL	20cc	CALL FOR BEST PRICE	Zoetis
 Fertagyl® Rx	A sterile solution containing 43 mcg/mL gonadorelin (GnRH) equivalent to 50 mcg/mL gonadorelin diacetate tetrahydrate, suitable for IM or IV administration to cattle for treatment of cystic ovaries.	Gonadorelin (GnRH) diacetate tetrahydrate	014148		20cc	CALL FOR BEST PRICE	Merck

Hormones & Analogs: Prostaglandins

All Rx items require veterinarian prescription.

PRODUCT	DESCRIPTION	ACTIVE INGREDIENT(S)	ITEM#	SIZE	PRICE	MFR.
Estrumate® Rx 	Cloprostenol sodium for IM use to induce luteolysis in beef and dairy cattle.	Cloprostenol sodium	002731	20cc	CALL FOR BEST PRICE	Merck
			030077	100cc	CALL FOR BEST PRICE	
EstroPLAN Rx 	Cloprostenol sodium is indicated for intramuscular use to induce luteolysis in beef and dairy cattle. The luteolytic action of estroPLAN can be utilized to manipulate the estrous cycle to better fit certain management practices, to terminate pregnancies resulting from mismatings, and to treat certain conditions associated with prolonged luteal function.	Cloprostenol sodium	026224 052077	20mL 100mL	CALL FOR BEST PRICE	Parnell
Lutalyse® Rx 	Dinoprost tromethamine sterile solution, used as a luteolytic agent in cattle, parturition induction in swine, and luteolytic effect in mares.	Dinoprost tromethamine	000735	30cc	CALL FOR BEST PRICE	Zoetis
			026256	100cc		

Breeding Supplies

	PRODUCT	DESCRIPTION	ITEM#	STRENGTH	SIZE	PRICE	MFR.
	AI Straws		038752		50 count	CALL FOR BEST PRICE	IMV International
	OB Lube	This all-purpose non-spermicidal lubricating jelly can be used as a lubricant for operator's hands and arms in obstetrical work, vaginal examinations and rectal examinations. May be used as a lubricant for catheters and stomach tubes.	019977		1 Gallon	CALL FOR BEST PRICE	Huvepharma
	OB Breeder Sleeves	An economical extra-long sleeve. Packaged in a convenient dispenser box.	024073	39" L x 1.0 ml thick	100 count	CALL FOR BEST PRICE	Neogen
			020826	36" x 1.0 ml			
	Estrotect Patches	The Estrotect Breeding Indicator features patent pending Breeding Bullseye Technology that indicates when cows are ready to breed, helps confirm pregnancies and provides pinpoint timing for AI protocols. Easy self-adhesive application Only need to apply once per breeding cycle Available in five fluorescent colors	092602	Red/Orange Fuchsia Blue Yellow Green	50 count	CALL FOR BEST PRICE	Rockway
	Kamar Adhesive	Kamar Heatmount Detector Back Tag Glue, Tube	000182		4.1 oz	CALL FOR BEST PRICE	Kamar
	ScratchE Pads	Has a protective top layer which is 'rubbed' off by themounting activity of herd mates. When this occurs, a bright under layer is revealed which clearly indicates a standing heat. Indicates amount of bulling activity. Superior self-adhesive strength. 5 bright colours. Moulds easily over the cow's backbone. Quick and easy one person application. Economical and reliable. Convenient strips of 5 patches.		Red/Orange Fuchsia Blue Yellow Green	50 count	CALL FOR BEST PRICE	Beacon
	Slap Shot Flexible Vaccinator	This is the original Slap-Shot—not a copy—with clear, flexible antibacterial tubing. Allows you to vaccinate or administer injectable products to animals in chutes, alleyways, crates or in the open. Attaches to any standard luer lock syringe and needle. Simply empty, rinse and sterilize to reuse.	036333		30"	CALL FOR BEST PRICE	Stone



EWTFR: Eastern & Western Encephalomyelitis, Tetanus, Influenza & Rhinopneumonitis

	PRODUCT	DESCRIPTION	ITEM#	SIZE	PRICE	MFR.
	Fluvac Innovator® 5	Encephalomyelitis-Rhinopneumonitis-Influenza Vaccine, Eastern and Western, Killed Virus, Tetanus Toxoid, horses	021039	1 Dose	CALL FOR BEST PRICE	Zoetis
				021038		
	Prestige® 4 with Havlogen®	Encephalomyelitis - Rhinopneumonitis - Influenza Vaccine, Eastern and Western, Killed Virus, Tetanus Toxoid, horses	017760	1 Dose		Merck
				017761		

EWTF: Eastern & Western Encephalomyelitis, Tetanus & Influenza

	PRODUCT	DESCRIPTION	ITEM#	SIZE	PRICE	MFR.
	Prestige 4®	Equine Encephalomyelitis-Influenza Vaccine, Eastern and Western, Killed Virus, Tetanus Toxoid, horses	014344	1 Dose	CALL FOR BEST PRICE	Merck
				014345		
	Fluvac Innovator® 4	Encephalomyelitis-Influenza Vaccine, Eastern and Western, Killed Virus, Tetanus Toxoid, horses	021035	1 Dose		Zoetis
				021034		

EWTR: Eastern & Western Encephalomyelitis, Tetanus & Rhinopneumonitis

	PRODUCT	DESCRIPTION	ITEM#	SIZE	PRICE	MFR.
	Prestige® 4 FoalShot with Havlogen®	Encephalomyelitis - Rhinopneumonitis Vaccine, Eastern and Western, Killed Virus, Tetanus Toxoid, horses 6 months and older	029890	1 Dose	CALL FOR BEST PRICE	Merck
				029889		



EWT: Eastern & Western Encephalomyelitis & Tetanus

	PRODUCT	DESCRIPTION	ITEM#	SIZE	PRICE	MFR.
	Encevac®-T with Havlogen®	Equine Encephalomyelitis Vaccine, Eastern and Western, Killed Virus, Tetanus Toxoid, horses	003878	1 Dose	CALL FOR BEST PRICE	Merck
				003879		
	Equiloid Innovator®	Encephalomyelitis Vaccine, Eastern and Western, Killed Virus, Tetanus Toxoid, horses	021033	1 Dose		Zoetis
				021030		





West Nile Virus & West Nile Virus Combinations

	PRODUCT	DESCRIPTION	ITEM#	SIZE	PRICE	MFR.
	Prestige 5 + WNV	Encephalomyelitis- Rhinopneumonitis - Inopneumonitis - Influenza - West Nile Virus vaccine, Eastern and Western, killed virus, killed flavivirus chimera, tetanus toxoid	037844	Single Dose	CALL FOR BEST PRICE	Merck
				10 Dose		
	Vetera Gold XP	Encephalomyelitis- Rhinopneumonitis - Inopneumonitis - Influenza - West Nile Virus vaccine, Eastern and Western, killed virus, killed flavivirus chimera, tetanus toxoid	049651	Single Dose		Boehringer Ingelheim
			049652	10 dose		



F: Influenza

	PRODUCT	DESCRIPTION	ITEM#	SIZE	PRICE	MFR.		
	Calvenza™ EIV	Equine Influenza Vaccine, Killed Virus, horses 6 months and older (including pregnant mares)	034434	1 Dose	CALL FOR BEST PRICE	Boehringer Ingelheim		
			034435	10 Dose				
	Flu Avert™ I.N.	Equine Influenza Vaccine, Modified Live Virus, for intranasal use only, horses 11 months and older	019183	10 x 1 Dose		CALL FOR BEST PRICE	Merck	
			020306	6 x 5 Dose				
	Fluvac Innovator®	Equine Influenza Vaccine, Killed Virus, horses	021027	1 Dose			CALL FOR BEST PRICE	Zoetis
			021026	10 Dose				

R: Rhinopneumonitis

	PRODUCT	DESCRIPTION	ITEM#	SIZE	PRICE	MFR.		
	Calvenza™ EHV*	Equine Rhinopneumonitis Vaccine, Killed Virus, horses 6 months and older (including pregnant mares)	023616	1 Dose	CALL FOR BEST PRICE	Boehringer Ingelheim		
			016031	10 Dose				
	EquiVac® Innovator EHV-1/4	Equine Rhinopneumonitis Vaccine, Killed Virus, horses	014487	10 Dose		CALL FOR BEST PRICE	Zoetis	
			014488	12 x 1 Dose				
	Pneumabort-K®+1b	Equine Rhinopneumonitis Vaccine, Killed Virus, horses	000960	10 Dose			CALL FOR BEST PRICE	Zoetis
			010679	12 x 1 Dose				
	Prestige Prodigy®	Equine rhinopneumonitis vaccine, killed virus, horses	011993	1 Dose	CALL FOR BEST PRICE			Merck
			011994	10 Dose				
	Rhinomune®	Equine Rhinopneumonitis Vaccine, Modified Live Virus, horses	001058	1 Dose		CALL FOR BEST PRICE		Boehringer Ingelheim
			001059	5 Dose				

FR: Influenza + Rhinopneumonitis

	PRODUCT	DESCRIPTION	ITEM#	SIZE	PRICE	MFR.		
	Calvenza™ EIV/EHV*	Equine Rhinopneumonitis-Influenza Vaccine, Killed Virus, horses 6 months and older (including pregnant mares)	034436	1 Dose	CALL FOR BEST PRICE	Boehringer Ingelheim		
			034437	10 Dose				
	Fluvac Innovator® EHV-4/1	Equine Rhinopneumonitis-Influenza Vaccine, Killed Virus, horses	021029	1 Dose		CALL FOR BEST PRICE	Zoetis	
			021028	10 Dose				
	Prestige 2®	Equine Rhinopneumonitis - Influenza Vaccine, Killed Virus, horses	014342	1 Dose			CALL FOR BEST PRICE	Merck
			014343	10 Dose				

Feed Supplements

	PRODUCT	DESCRIPTION	SIZE	PRICE
	Zesterra	An all natural prebiotic supplement designed for horses during times of stress. Encourages feed and water consumption safely balancing the pH of the stomach.	250 ml	\$85.00
			500 ml	\$140.00
			Gallon	\$725.00



Open Spaces Photography

EQUINE VACCINE COMPARISON CHART







DESCRIPTIONS AND PRODUCT PRICING – PAGE 72-74

ZOETIS	ENCEPHALOMYELITIS		INFLUENZA EIV	TETANUS	WEST NILE	EQUINE HERPESVIRUS (RHINOPNEUMONITIS) EHV
	EEE/WEE	VEE				
FLUVAC INNOVATOR® 4	X		X	X		X
FLUVAC INNOVATOR® 5	X		X	X		X
FLUVAC INNOVATOR® 6	X	X	X	X		X
FLUVAC INNOVATOR® EHV-4/1			X			X
FLUVAC INNOVATOR® TRIPLE-E FT®	X	X	X	X		
WEST NILE FLUVAC INNOVATOR® + EWT	X			X	X	

MERCK	ENCEPHALOMYELITIS		INFLUENZA EIV	TETANUS	WEST NILE	EQUINE HERPESVIRUS (RHINOPNEUMONITIS) EHV
	EEE/WEE	VEE				
PRESTIGE® II WITH HAVLOGEN			X			X
PRESTIGE® V WITH HAVLOGEN	X		X	X		X
PRESTIGE® V+WNV WITH HAVLOGEN	X		X	X	X	X
ENCEVAC® T WITH HAVLOGEN	X		X	X		X
PRESTIGE 4	X		X	X		

BOEHRINGER INGELHEIM	ENCEPHALOMYELITIS		INFLUENZA EIV	TETANUS	WEST NILE	EQUINE HERPESVIRUS (RHINOPNEUMONITIS) EHV
	EEE/WEE	VEE				
VETERA® GOLD	X		X	X	X	X
VETERA® EWT + WEST NILE	X		X	X	X	X
VETERA® VEWT + WEST NILE	X	X		X	X	
CALVENZA® -03 EIV/EHV			X			X

Dewormers

	PRODUCT	DESCRIPTION	ITEM#	SIZE	MFR.	PRICE
	Equimax Paste	For the treatment and control of roundworms, tapeworms, lungworms and bots in horses with a single dose. Contains ivermectin/ praziquantel	022195	1 Dose 12 or more	Zoetis	CALL FOR BEST PRICE
	Eqvalan Paste	Controls large and small strongyles, pinworms, ascarids, hairworms and threadworms. Use in horses of any age, including pregnant or nursing mares. Contains 1.87% ivermectin .	005024	1 Dose 12 or more		
	Exodus Paste	Exodus Paste horse wormer contains pyrantel pamoate for removal and control of mature infections of large and small strongyles, pinworms and roundworms in horses and ponies. Each 1-dose syringe treats up to 1200 lbs. body weight. Exodus is safe for use in foals, pregnant mares and stallions. Palatable apple flavor.	02741	23.6 gm		
	Zimecterin Gold Paste	An equine dewormer combining ivermectin and praziquantel for complete parasite control	022256	1 Dose 12 or more		
	Safeguard Paste	Safe-Guard Equine Paste Horse Wormer is 10% Fenbendazole paste for the safe and effective control of large and small strongyles, pinworms, and roundworms. Safe for pregnant mares, stallions, and foals.	043527	25 gm		
	Strongid Paste	Use in horses & foals for the removal & control of mature infections of large & small strongyles, pinworms & large roundworms. Pyrantel pamoate base .	003282	1 Dose 12 or more		
	Quest Gel	Use in horses, ponies, breeding mares, stallions & foals over 4 months of age for the treatment & Control of large & small strongyles, pinworms, ascarids, hairworms, stomachworms, bots & encysted small strongyles. Offers year-round control in only 4 treatments. Delays the reappearance of worm eggs for 84 days. Follow instructions closely. Contains moxidectin/praziquantel	027264	1 Dose 12 or more		

• Rotational Equine Deworming, veterinarians recommend deworming every two months."

Saddles

	DESCRIPTION	SIZE	PRICE		DESCRIPTION	SIZE	PRICE
	DeTye Youth Saddle Kid tested, cowboy approved. This saddle has a rawhide covered wood tree just like mom and dad's big saddles. It fits a pony just fine, but is built to fit a big horse. It has quarter horse bars in it.	10 inch 12 inch 13 inch	\$750		DeTye Youth Roper Saddle	13 inch 13.5 inch	

MADE FOR DETYE VET SUPPLY.

We proudly carry a selection of your top equine brands.





DeTye Vet Supply, Inc.
21336 Harp Road
Sturgis, SD 57785



Like DeTye Vet Supply on Facebook
to follow our latest updates & news.

To view this digital catalog,
visit our website at
DETYE.COM.



Open Spaces Photography